

# 欧标30系列铝合金型材(实用型)

槽宽8.2 · 边长30/60mm

代码	材质	表面处理
AOB05	A6063-T5	喷砂氧化

- ① 提供可选加工服务。
- ② 切断面未进行氧化处理。
- ③ 最大使用长度：5800~5850mm；  
整条标准长度：6000~6020mm。
- ④ 可定制表面处理。

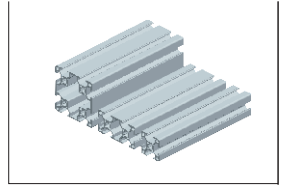

■ L长度公差



■ 槽口详图

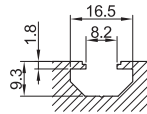

AOB05-J1530A

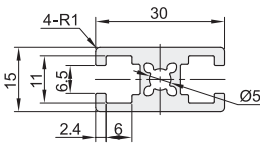

AOB05-J3030

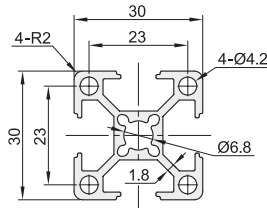

AOB05-J3030G

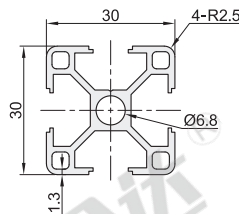

AOB05-J3030A

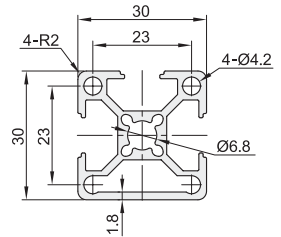

AOB05-J3030B

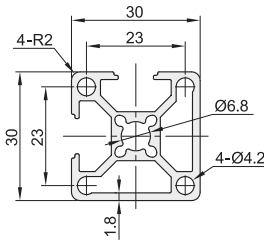

AOB05-J3030H

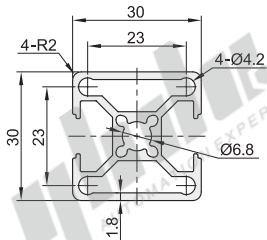

AOB05-J3030T

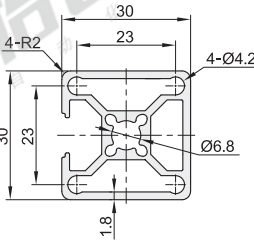

AOB05-J3030RS

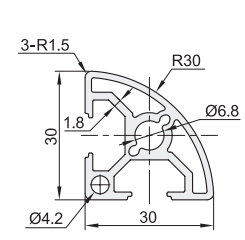

AOB05-J3030R

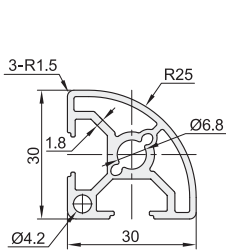

AOB05-J3060

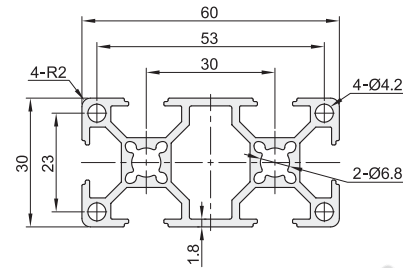

AOB05-J3060G

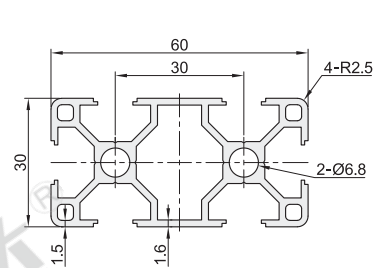

AOB05-J3060A

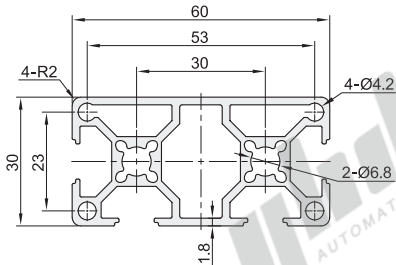

AOB05-J3060B

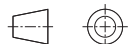
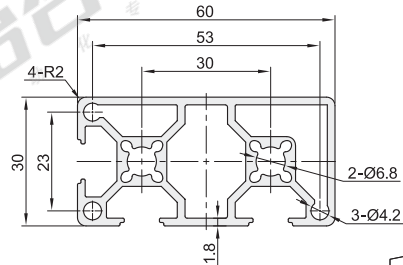

视角标准：第一视角

AOB05-J3090

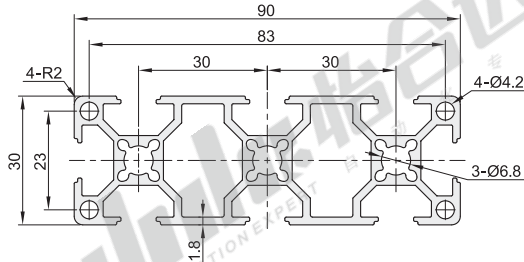

AOB05-J6630R

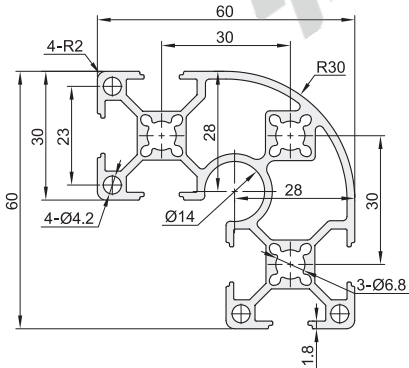

AOB05-J6630RA

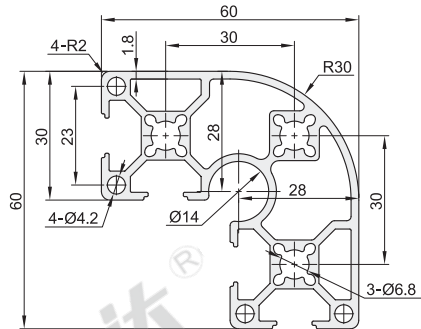

AOB05-J6060

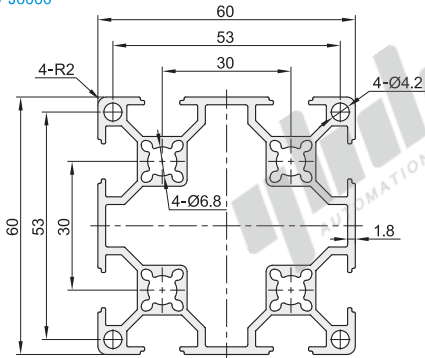

AOB05-J6060S

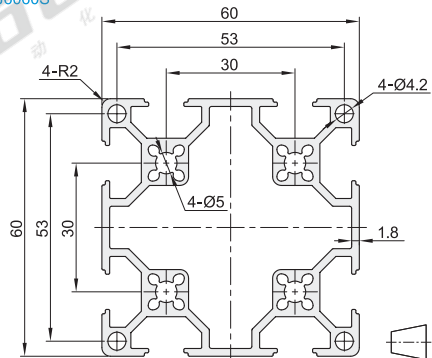

视角标准：第一视角

型号 代码	规格	L 最小单位0.5	截面尺寸	每米重量Kg/m (理论值)	截面积 (mm <sup>2</sup> )	截面惯性矩		抗弯截面模数	
						$I_x$	$I_y$	$W_{xmax}(mm^3)$	$W_{ymax}(mm^3)$
AOB05	J1530A	50~6000	15×30	0.61	221.89	$0.668 \times 10^4$	$1.400 \times 10^4$	445.33	1866.67
	J3030			0.77	278.71	$2.618 \times 10^4$	$2.618 \times 10^4$	1745.33	1745.33
	J3030G			0.68	246.20	$2.31 \times 10^4$	$2.31 \times 10^4$	1538.72	1538.65
	J3030A		0.78	283.58	$2.801 \times 10^4$	$2.535 \times 10^4$	1867.33	1690.00	
	J3030B		0.83	300.02	$2.838 \times 10^4$	$2.838 \times 10^4$	1892.00	1892.00	
	J3030H		0.80	288.45	$2.984 \times 10^4$	$2.451 \times 10^4$	1989.33	1634.00	
	J3030T		0.84	304.89	$2.996 \times 10^4$	$2.763 \times 10^4$	1900.70	1841.99	
	J3030R		0.73	262.91	$2.128 \times 10^4$	$2.128 \times 10^4$	1309.54	1309.54	
	J3030RS		0.71	258.59	$1.989 \times 10^4$	$1.989 \times 10^4$	1200.12	1200.12	
	J3060		1.37	498.49	$4.803 \times 10^4$	$17.944 \times 10^4$	1601.00	11962.67	
	J3060G		1.27	458.95	$4.44 \times 10^4$	$16.89 \times 10^4$	1481.66	11260.16	
	J3060A		1.44	522.80	$5.318 \times 10^4$	$18.217 \times 10^4$	1782.81	11604.57	
	J3060B		1.43	519.84	$5.220 \times 10^4$	$18.481 \times 10^4$	1739.95	11879.76	
	J3090		1.97	714.68	$6.980 \times 10^4$	$55.694 \times 10^4$	1551.11	37129.33	
	J6630R		1.91	692.02	$21.530 \times 10^4$	$21.530 \times 10^4$	6394.42	6394.42	
	J6630RA		2.00	724.93	$23.182 \times 10^4$	$23.182 \times 10^4$	6852.50	6852.50	
J6060	2.17	787	$31.728 \times 10^4$	$31.728 \times 10^4$	10576.00	10576.00			
J6060S	2.23	810.81	$32.692 \times 10^4$	$32.692 \times 10^4$	10897.23	10897.23			



请按图示订货

型号	规格	L 最小单位0.5	截面尺寸
AOB05	J3030 J4030A	50<D00	30×30

AOB05—J3030A—L450