

欧标40槽宽8.2系列铝合金型材

◀ 边长40/60mm

代码	材质	表面处理
AOB03	A6063-T5	黑色氧化
AOB05		喷砂氧化
AMS05		

- ① 切断面未进行氧化处理。
- ② 最大使用长度：5800~5850mm；
整条标准长度：6000~6020mm。
- ③ 可定制表面处理。



☑ L长度公差

L ≤ 1000mm

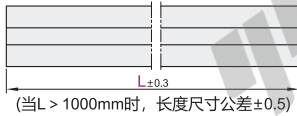

☑ 槽口详图

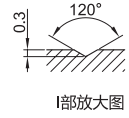
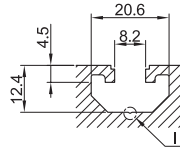
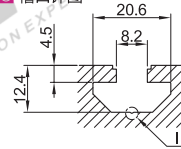

AOB05-4040

重量:1.65Kg/m

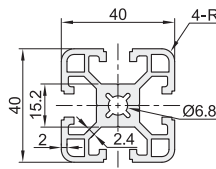

AOB05-4040C

重量:1.19Kg/m

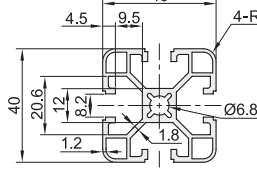

AOB03-4040E
AOB05-4040E

重量:1.68Kg/m

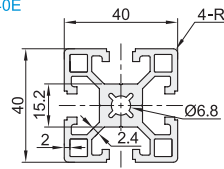

AOB05-4040F

重量:1.48Kg/m

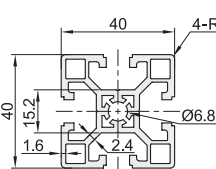

AOB03-4040J
AOB05-4040J

重量:2.06Kg/m

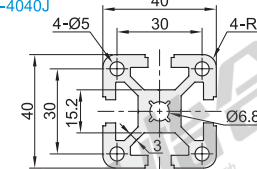

AOB05-4040A

重量:1.62Kg/m

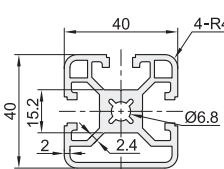

AOB05-4040B

重量:1.64Kg/m

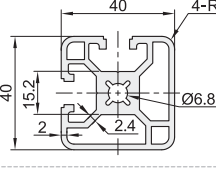

AOB05-4040H

重量:1.6Kg/m

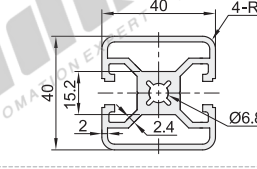

AOB05-4040T

重量:1.6Kg/m

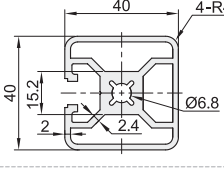

AOB05-4040R

重量:1.5Kg/m

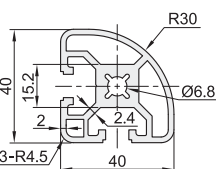

AOB03-4040RE
AOB05-4040RE

重量:1.5Kg/m

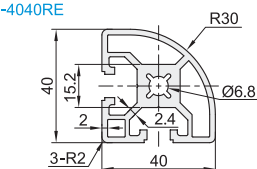

AOB05-4040XE

重量:1.41Kg/m

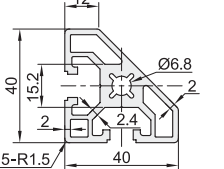

AOB05-4430

重量:1.66Kg/m

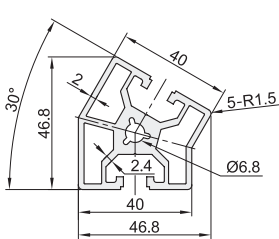

AOB05-4445

重量:1.66Kg/m

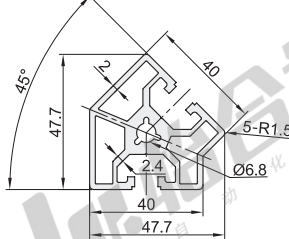

AOB05-4460

重量:1.67Kg/m

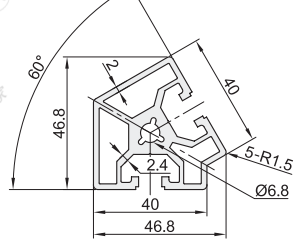

AOB05-4040HC
折叠门型材

重量:1.56Kg/m

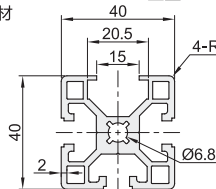

AMS05-OB40-E

重量:1.67Kg/m

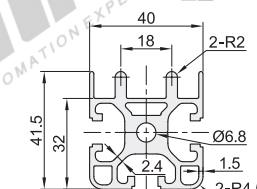

AOB05-4060

重量:2.35Kg/m

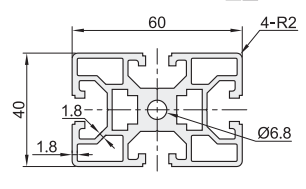

AOB05-4060A

重量:2.26Kg/m

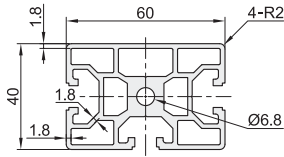

AOB05-4080

重量:2.99Kg/m

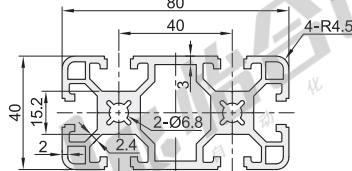

AOB05-4080C

重量:2.09Kg/m

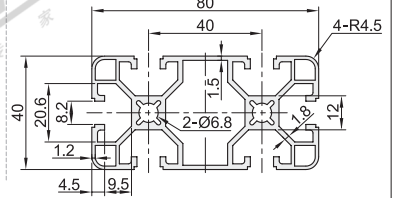

AOB03-4080E
AOB05-4080E

重量:3.01Kg/m

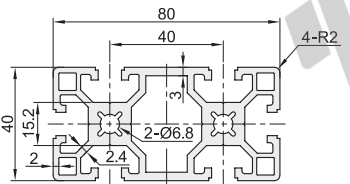

AOB05-4080F

重量:2.64Kg/m

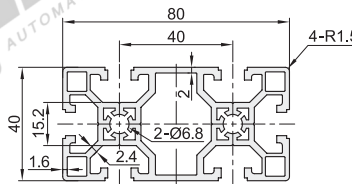

AOB03-4080J
AOB05-4080J

重量:4.01Kg/m

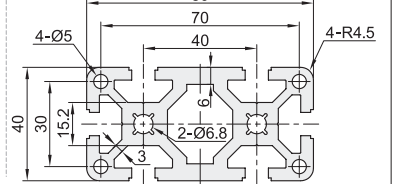

AOB05-4080A

重量:2.7Kg/m

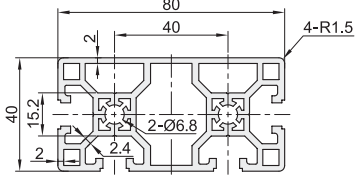

AOB05-4080FA

重量:2.65Kg/m

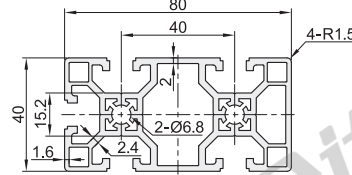

AOB05-4080B

重量:2.71Kg/m

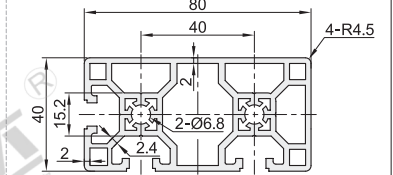

AOB05-4080H

重量:2.71Kg/m

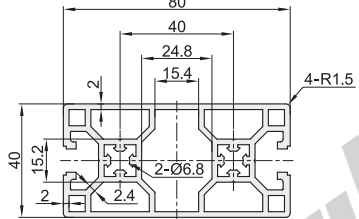

AOB05-40120E

重量:4.15Kg/m

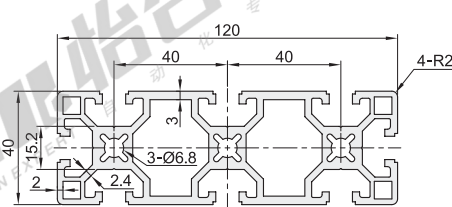

AOB05-40160

重量:4.87Kg/m

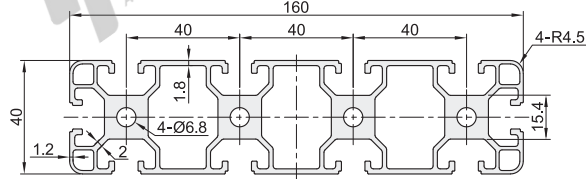

AOB05-40160E

重量:5.41Kg/m

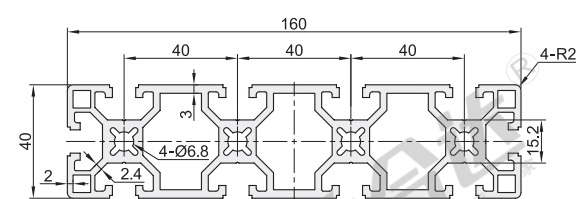

AOB05-40200E

重量:6.36Kg/m

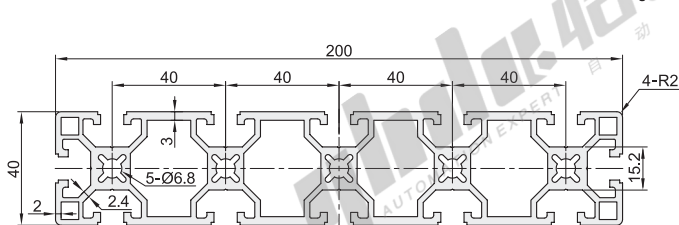

AOB05-8840

重量:4Kg/m

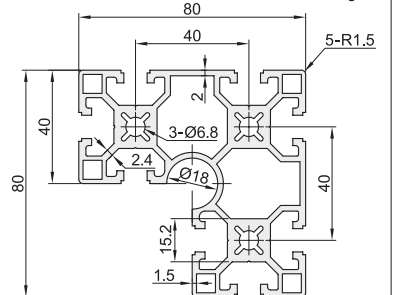

欧标40槽宽8.2系列铝合金型材

◀ 边长80/120mm

AOB05-8840R

重量:3.5Kg/m

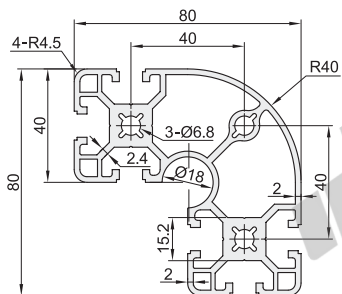

AOB05-8840RE

重量:3.57Kg/m

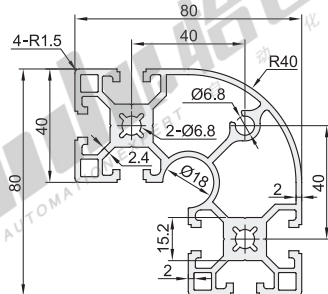

AOB05-8840RF

重量:3.1Kg/m

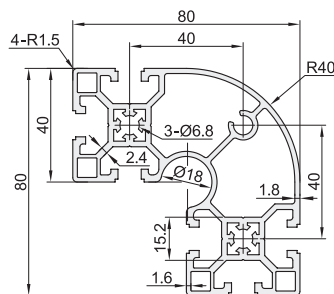

AOB05-8840RY

重量: 3.46Kg/m

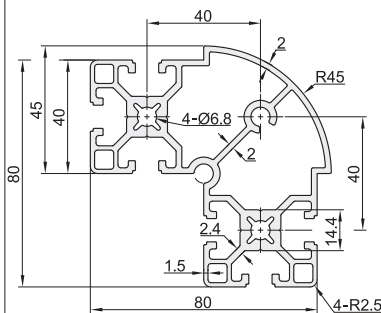

AOB05-8080

重量:4.75Kg/m

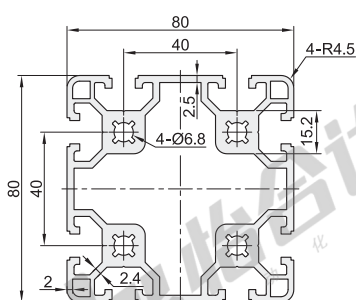

AOB05-8080A

重量:4.08Kg/m

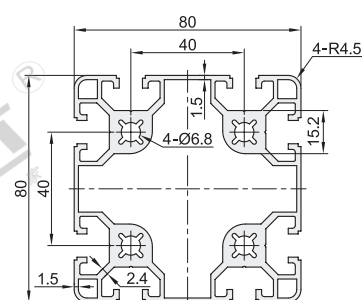

AOB03-8080E
AOB05-8080E

重量:4.52Kg/m

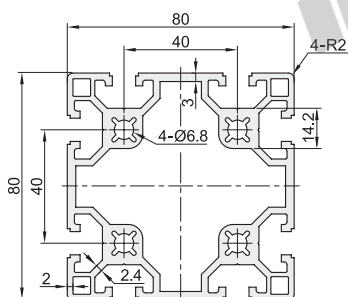

AOB05-8080F

重量:4.16Kg/m

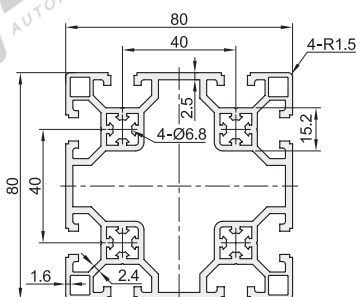

AOB05-8080FA

重量:4.15Kg/m

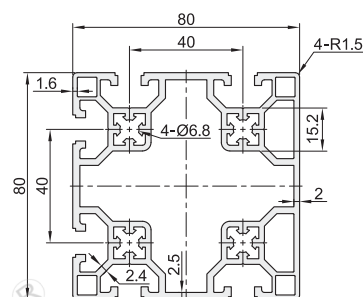

AOB05-8080J

重量:6.35Kg/m

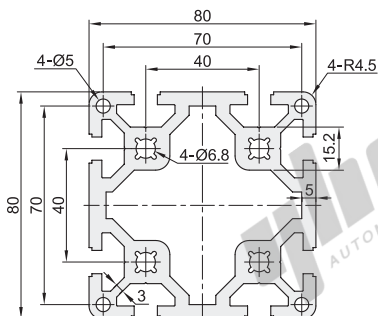

AOB05-80120E

重量:7.89Kg/m

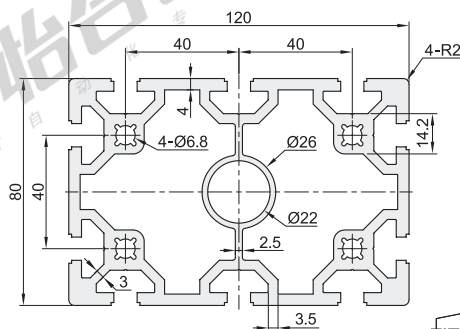

AOB05-80160E

重量:10.29Kg/m

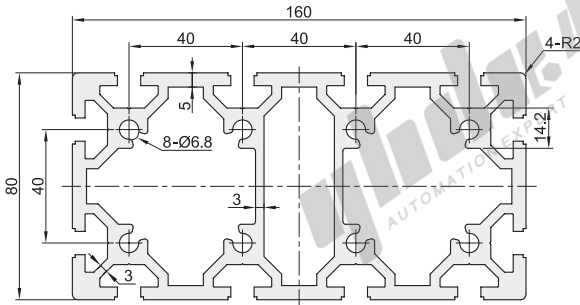

AOB05-120120E

重量:11.03Kg/m

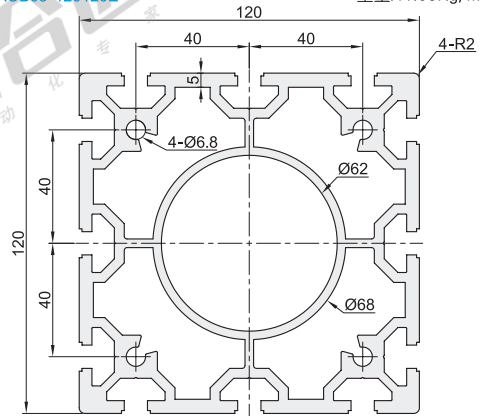

AOB05-120120G

重量:14.23Kg/m

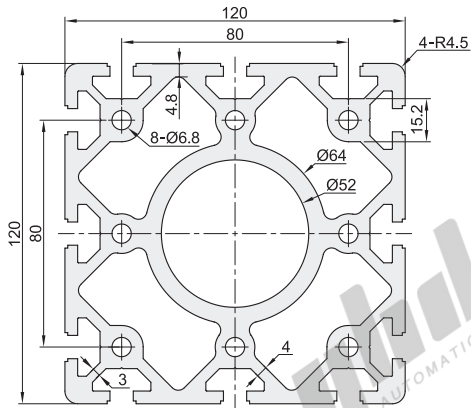

AOB05-160160E

重量:16.08Kg/m

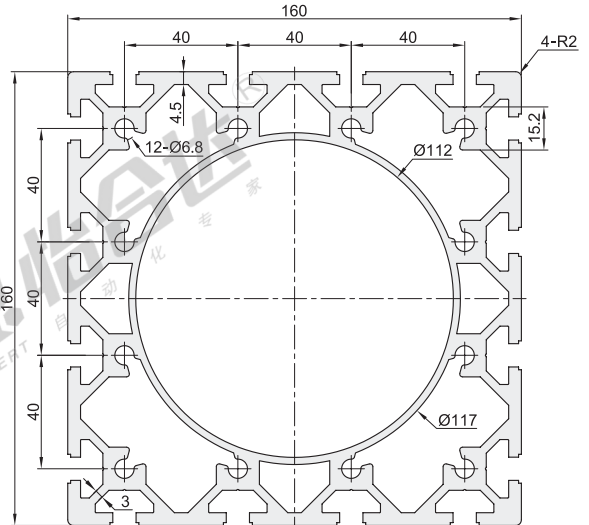

AOB05-200200E

重量:21.72Kg/m

