

锌合金蝶形铰链

◀ 工字型

代码	类型		材质	表面处理/颜色
HFS22		锥孔+螺孔型		喷塑(纱纹黑)
HFS23		锥孔+定位柱型		喷塑(黑淡光)
HFS24	工字型	内折型	ZDC	喷塑(RAL7035细橘纹)
HFS25		锥孔+螺孔型		喷塑(淡蓝)
HFS26		螺孔型		喷塑(淡蓝)

HFS22

HFS25



HFS22(锥孔+螺孔型)

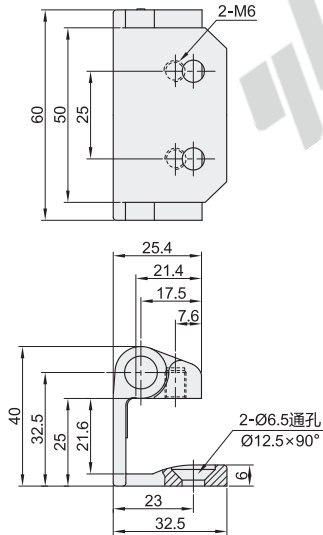

安装图

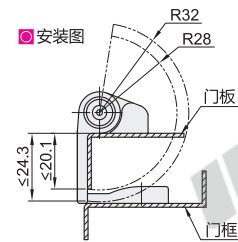

HFS24(台阶孔+螺孔型)

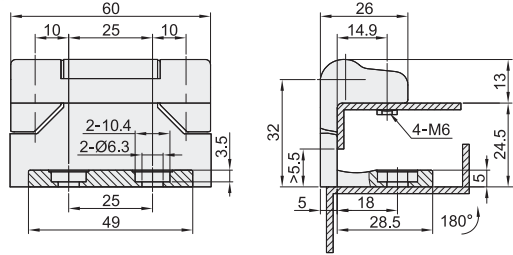

门板开孔

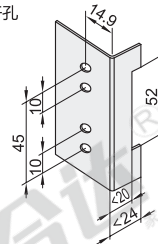

HFS25(锥孔+螺孔型)

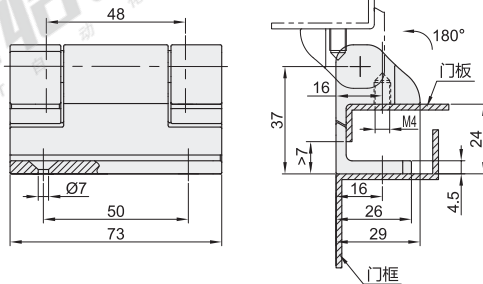

HFS23(锥孔+定位柱型)

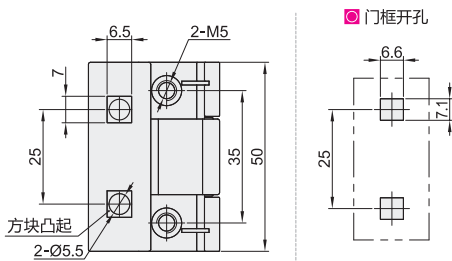

HFS26(螺孔型)

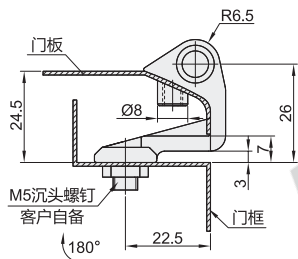
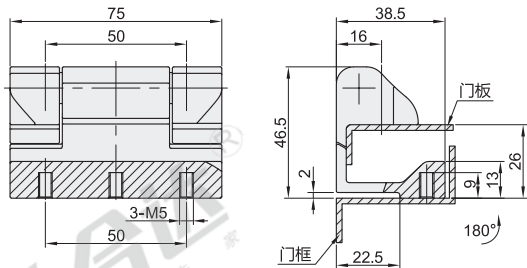

视角标准: 第一视角

型号	规格	负载 (Kg)	参考重量 (Kg/pcs)
HFS22	60	15	0.18
HFS23	50	23.7	0.07
HFS24	60	15.7	0.168
HFS25	73	28.7	0.25
HFS26	75	30	0.12

容许负载为使用2个时的数值。



请按图示订货

型号	规格
HFS22	60
HFS23	50

HFS22—60



未税价(元)

优惠价

数量 1~9 10~

价格 100% 另行报价



交货期

3