

特点

- 外形统一尺寸为75&105，实现小型化，标准化；
- 单触式端子盖，实现使用便利；
- 对应隔离功能，适用于机械成套设备；
- 符合GB规格及IEC规格。

CCC CE IEC



NFC30-SMX

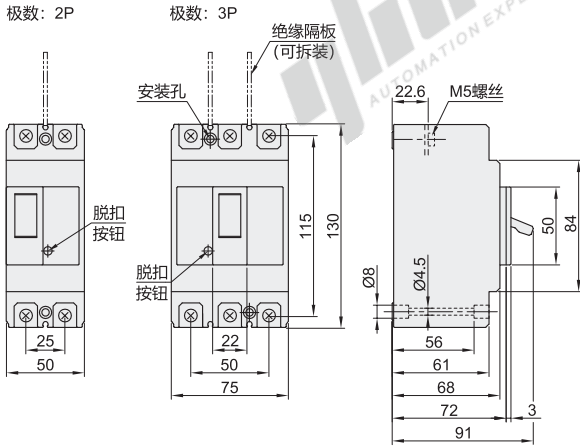

钻孔图

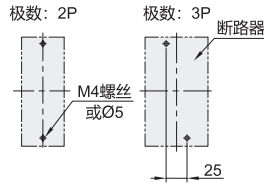

面板尺寸图

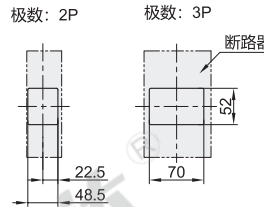

自付接续铜带加工图

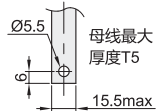

NFC60-CMXA  
NFC100-CMXA

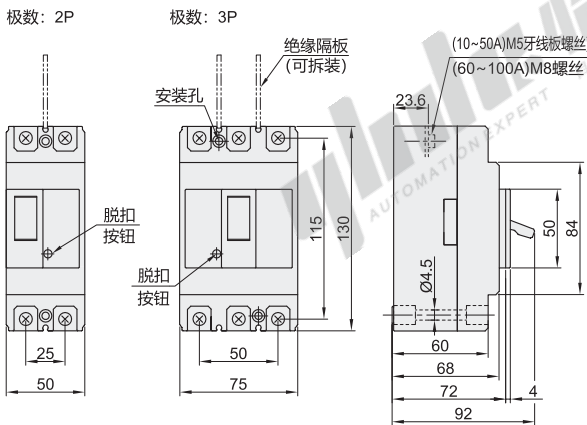

钻孔图

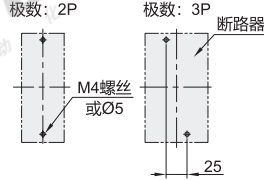

面板尺寸图

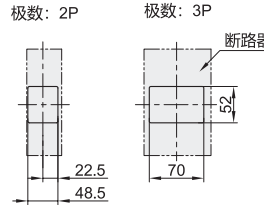

自付接续铜带加工图

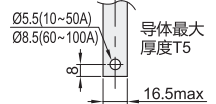

NFC160-CMXA  
NFC250-CMXA

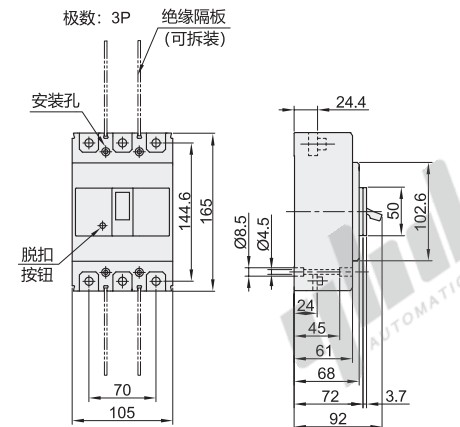

钻孔图

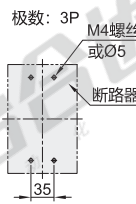

面板尺寸图

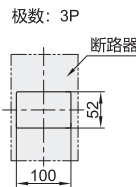

自付接续铜带加工图

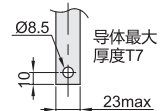

# MXA系列塑壳断路器

2极/3极  
三菱品牌

型号	额定电流(A)	极数	分段能力	壳架等级	接线方式
NFC30-SMX 2P 3A	3				
NFC30-SMX 2P 4A	4				
NFC30-SMX 2P 6A	6				
NFC30-SMX 2P 10A	10				
NFC30-SMX 2P 15A	15	2P			
NFC30-SMX 2P 20A	20				
NFC30-SMX 2P 25A	25				
NFC30-SMX 2P 30A	30		5KA/AC 400V	30A	
NFC30-SMX 3P 3A	3		7.5KA/AC 230V		
NFC30-SMX 3P 4A	4				
NFC30-SMX 3P 6A	6				
NFC30-SMX 3P 10A	10	3P			
NFC30-SMX 3P 15A	15				
NFC30-SMX 3P 20A	20				
NFC30-SMX 3P 25A	25				
NFC30-SMX 3P 30A	30				
NFC60-CMXA 2P 16A	16				
NFC60-CMXA 2P 20A	20				
NFC60-CMXA 2P 25A	25				
NFC60-CMXA 2P 32A	32	2P			
NFC60-CMXA 2P 40A	40				
NFC60-CMXA 2P 50A	50				
NFC60-CMXA 2P 60A	60		5KA/AC 400V	60A	
NFC60-CMXA 3P 16A	16		7.5KA/AC 230V		
NFC60-CMXA 3P 20A	20				
NFC60-CMXA 3P 25A	25				
NFC60-CMXA 3P 32A	32	3P			
NFC60-CMXA 3P 40A	40				
NFC60-CMXA 3P 50A	50				
NFC60-CMXA 3P 60A	60				
NFC100-CMXA 2P 16A	16				
NFC100-CMXA 2P 20A	20				
NFC100-CMXA 2P 25A	25				
NFC100-CMXA 2P 32A	32				
NFC100-CMXA 2P 40A	40				
NFC100-CMXA 2P 50A	50	2P			
NFC100-CMXA 2P 60A	60				
NFC100-CMXA 2P 63A	63				
NFC100-CMXA 2P 75A	75				
NFC100-CMXA 2P 80A	80				
NFC100-CMXA 2P 100A	100		10KA/AC 400V	100A	
NFC100-CMXA 3P 16A	16		25KA/AC 230V		
NFC100-CMXA 3P 20A	20				
NFC100-CMXA 3P 25A	25				
NFC100-CMXA 3P 32A	32				
NFC100-CMXA 3P 40A	40				
NFC100-CMXA 3P 50A	50				
NFC100-CMXA 3P 60A	60				
NFC100-CMXA 3P 63A	63				
NFC100-CMXA 3P 75A	75				
NFC100-CMXA 3P 80A	80				
NFC100-CMXA 3P 100A	100	3P			
NFC160-CMXA 3P 125A	125				
NFC160-CMXA 3P 140A	140		15KA/AC 400V	160A	
NFC160-CMXA 3P 150A	150		30KA/AC 230V		
NFC160-CMXA 3P 160A	160				
NFC250-CMXA 3P 175A	175				
NFC250-CMXA 3P 200A	200		15KA/AC 400V	250A	
NFC250-CMXA 3P 225A	225		30KA/AC 230V		
NFC250-CMXA 3P 250A	250				

板前接线  
压接端子

动作特性曲线

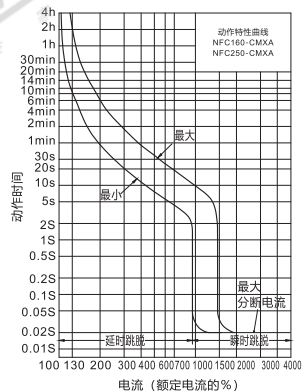
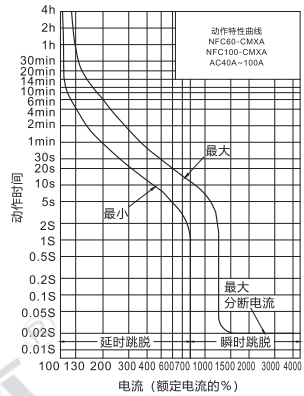
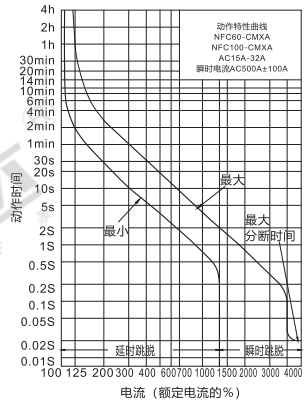
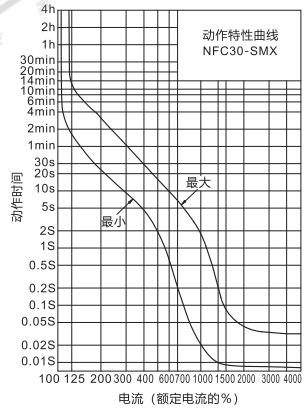

断路器



请按图示订货

代码  
NFC30-SMX 2P 3A  
NFC30-SMX 2P 4A  
NFC30-SMX 2P 3A

报价  
方式



■ 技术参数

型号		NFC30-SMX	NFC60-CMXA	NFC100-CMXA	NFC160-CMXA	NFC250-CMXA	
壳架电流(A)		30	60	100	160	250	
分断能力级别		S	C	C	C	C	
额定电流In(A)		3 4 6 10 15 20 25 30	16 20 25 32 40 50 60	16 20 25 32 40 50 60 63 75 80 100	125 140 150 160(注1)	175 200 225 250(注1)	
额定环境温度 (°C)		40					
极数		2P 3P	2P 3P	2P 3P	3P	3P	
额定绝缘电压 Ui (V AC)		690					
额定断路 分断能力 (KA)	IEC60947-2 EN60947-2 (Icu/Ics)	AC	415V	5/2.5	5/2.5	10/5	15/7.5
			400V	5/2.5	5/2.5	10/5	15/7.5
			380V	5/2.5	5/2.5	15/7.5	22/11
	230V		7.5/4	7.5/4	25/12.5	30/15	
	GB14048.2 (Icu/Ics)		400V	5/2.5	5/2.5	10/5	15/7.5
			230V	7.5/4	7.5/4	25/12.5	30/15
额定冲击耐压Ui (V AC)		8	8	8	8	8	
工作周期数 (次)		不通电	10000	10000	10000	8000	
		通电	1500	1500	1500	1000	
使用类别		A	A	A	A	A	
污染等级		3	3	3	3	3	
安装与连接 (板前接线 F)		压接端子	压接端子	压接端子	压接端子	压接端子	
脱扣方式		完全电磁	热动-电磁	热动-电磁	热动-电磁	热动-电磁	
认证	CCC	取得	取得	取得	取得	取得	
	CE	自我声明	自我声明	自我声明	自我声明	自我声明	

注1 NFC160-CMXA、NFC250-CMXA为额定电流可调型。(额定电流的0.8倍、1.0倍。例：125A可调整电流为100A和125A)