

### 成品订购码

BPC 6 01 □

① ② ③ ④

① 规格代号	② 接管口径	③ 连接螺纹	④ 牙型代号
BPC: 全金属螺纹直通 	4: $\Phi$ 4mm 6: $\Phi$ 6mm 8: $\Phi$ 8mm 10: $\Phi$ 10mm 12: $\Phi$ 12mm	M5: M5X0.8 01: PT1/8 02: PT1/4 03: PT3/8 04: PT1/2	空白: PT牙
BPCF: 全金属内螺纹直通 			
BPOC: 全金属圆螺纹直通 	BPMF: 全金属内牙穿板直通 		

BPM 6

① ②

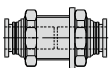
① 规格代号	② 接管口径
BPM: 全金属穿板直通 	4: $\Phi$ 4mm 6: $\Phi$ 6mm 8: $\Phi$ 8mm 10: $\Phi$ 10mm 12: $\Phi$ 12mm

### 产品规格

使用压力范围	0~9kgf/cm <sup>2</sup> (0~0.9MPa)
负压	-750mmHg(10Torr)
保证耐压力	1.5MPa
使用温度范围(°C)	0~150
适用软管	尼龙软管或PU管
颜色	灰色/黑色

[注] 高温场合使用时, 需确认软管或PU管耐温等级。

### 产品特性

- 属于全金属螺纹类接头, 产品内部部分零件含铜; 有多种型号规格可选, 广泛应用于各类气动系统;
- 流通性能优越, 可通过与气管内径同容量之流量;
- 拔插接管简单方便又快捷, 与气管连接部份安全可靠又耐用;
- 螺纹部分涂密封胶, M5公制螺纹附密封垫片, 确保螺纹连接部份无泄漏;
- 镀镍的金属体可以防腐蚀和污染, 应用范围更宽广;
- 全金属接头适用于高温环境。

### 接口端螺纹与插管端内径配置表

产品系列	螺纹规格	插管口径				
		$\Phi$ 4	$\Phi$ 6	$\Phi$ 8	$\Phi$ 10	$\Phi$ 12
BPC	M5	●	●			
	PT1/8	●	●	●	●	
	PT1/4	●	●	●	●	●
	PT3/8		●	●	●	●
	PT1/2				●	●
BPOC BPCF	M5	●	●			
	PT1/8	●	●	●		
	PT1/4		●	●	●	
	PT3/8				●	●
	PT1/2					●
BPMF	M5					
	PT1/8	●	●	●		
	PT1/4		●	●	●	
	PT3/8				●	●
	PT1/2					●

产品系列	插管口径				
	$\Phi$ 4	$\Phi$ 6	$\Phi$ 8	$\Phi$ 10	$\Phi$ 12
BPM	●	●	●	●	●

### 内部结构

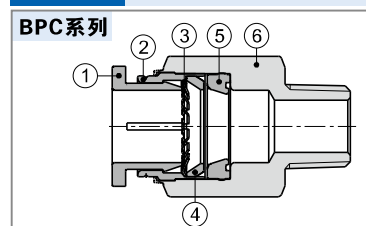

序号	名称	材质
1	金属接口	铝合金
2	定位环	铝合金
3	弹簧垫片	不锈钢
4	定位座	铝合金
5	异型O令	氟橡胶
6	直通接头本体	黄铜

# 辅助元件——管接头

## 插管—全金属螺纹类

### 外部规格

#### BPC系列

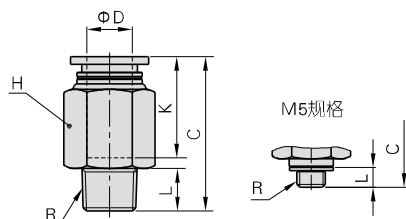

型号\符号	ΦD	R	L	C	K	对边H	重量(g)
BPC4M5	4	M5X0.8	3.5	19.5	14	9	5.5
BPC401		PT1/8	7.5	19.5	14	10	7.9
BPC402		PT1/4	10	19	14	14	8.7
BPC6M5	6	M5X0.8	3.5	22	16	12	10.1
BPC601		PT1/8	7.5	21.5	18	12	14.2
BPC602		PT1/4	10	24	18	14	19.1
BPC603	8	PT3/8	11	22.5	18	17	26.8
BPC801		PT1/8	7.5	27.5	18	14	16.1
BPC802		PT1/4	10	26.5	18	14	16
BPC803	10	PT3/8	11	23	18	17	25.4
BPC1001		PT1/8	7.5	29.5	20.5	17	24.5
BPC1002		PT1/4	10	32	20.5	17	28
BPC1003	12	PT3/8	11	27.5	20.5	17	34.6
BPC1004		PT1/2	14	25.5	20.5	21	39.3
BPC1202		PT1/4	10	34.5	22	21	44.5
BPC1203	12	PT3/8	11	30	22	21	34.2
BPC1204		PT1/2	14	32	22	21	47

#### BPOC系列

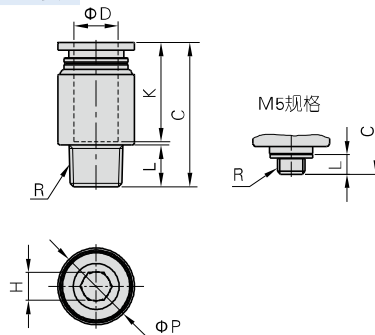

型号\符号	ΦD	R	ΦP	L	C	K	对边H	重量(g)
BPOC4M5	4	M5X0.8	9	3.5	18.5	14	2	4.4
BPOC401		PT1/8	10	7.5	17.5	14	2.5	6.6
BPOC6M5	6	M5X0.8	12	3.5	21	16	2	7.1
BPOC601		PT1/8	12	7.5	21.5	18	4	8.4
BPOC602	8	PT1/4	14	10	21.5	18	4	13.6
BPOC801		PT1/8	14	7.5	26	17.5	5	12.3
BPOC802	10	PT1/4	14	10	24.5	17.5	6	12.7
BPOC1002		PT1/4	17	10	28.5	20.5	6	18.5
BPOC1003	12	PT3/8	17	11	27.5	20.5	8	24.9
BPOC1203		PT3/8	21	11	29.5	22	8	30.4
BPOC1204	12	PT1/2	21	14	31.5	22	8	42.4

#### BPCF系列

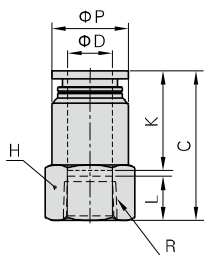

型号\符号	ΦD	R	ΦP	L	C	K	对边H	重量(g)
BPCF4M5	4	M5X0.8	9	5	21	14	10	3.5
BPCF401		PT1/8	9.5	8	23	14	14	5.3
BPCF6M5	6	M5X0.8	12	5	21	16	12	5.6
BPCF601		PT1/8	12.5	8	25	16	14	7.2
BPCF602	8	PT1/4	12.5	11	28	16	17	9.2
BPCF801		PT1/8	14	8	27	18	14	7.1
BPCF802	10	PT1/4	14.5	11	30	18	17	10.6
BPCF1002		PT1/4	17	11	32.5	20.5	17	13.5
BPCF1003	12	PT3/8	18	12	33.5	20.5	21	17.5
BPCF1203		PT3/8	21	12	35	22	21	22
BPCF1204	12	PT1/2	21	13.5	36.5	22	25	24.9

#### BPMF系列

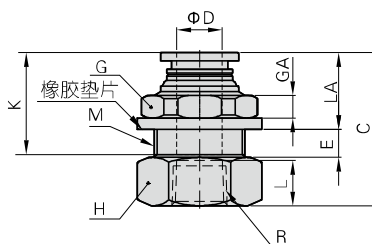

型号\符号	ΦD	R	M	L	C	K	LA	E	GA	对边G	对边H	重量(g)
BPMF401	4	PT1/8	M12X1	8	25	14	12	4	4	14	14	7.6
BPMF601		PT1/8	M14X1	8	25	16	12	5	4	17	17	10.4
BPMF602	6	PT1/4	M14X1	11	30	16	12	5	4	17	17	12.2
BPMF801		PT1/8	M16X1	8	27	18	13	5.5	4	19	19	13.9
BPMF802	8	PT1/4	M16X1	11	31.5	18	13	5.5	4	19	19	15.3
BPMF1002		PT1/4	M20X1	11	34.5	20.5	14	7.5	5	24	22	26.2
BPMF1003	10	PT3/8	M20X1	12	35.5	20.5	14	7.5	5	24	22	24.4
BPMF1203		PT3/8	M22X1	12	37	22	15	8	6	27	24	32.6
BPMF1204	12	PT1/2	M22X1	13.5	38.5	22	15	8	6	27	25	31.8

#### BPM系列

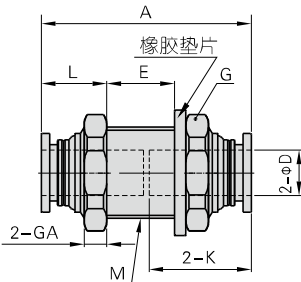

型号\符号	ΦD	M	A	K	L	E	GA	对边G	重量(g)
BPM4	4	M12X1	28.5	14	10	7	4	14	6.4
BPM6	6	M14X1	33	16	10	11	4	17	16.4
BPM8	8	M16X1	37	18	11	13	4	19	15.8
BPM10	10	M20X1	41.5	20.5	12	16	5	24	28.9
BPM12	12	M22X1	45	22	13	17.5	6	27	40.3