

倍速链系列铝合金型材

代码	材质	表面处理
ATS05	A6063-T5	喷砂氧化
ATS06	A6063-T5	喷砂电泳

- ① 切断面未进行氧化处理。
- ② 最大使用长度：5800~5850mm；
整条标准长度：6000~6020mm。
- ③ 根据设计需求，可来图定制加工。
- ④ 可定制表面处理。

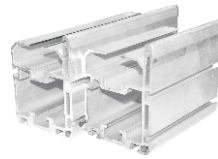

⑤ L长度公差

$L \leq 1000\text{mm}$

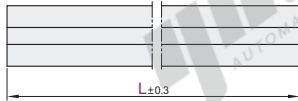

(当 $L > 1000\text{mm}$ 时，长度尺寸公差 ± 0.5)

⑥ 槽口详图

(ATS06-SE148C除外)

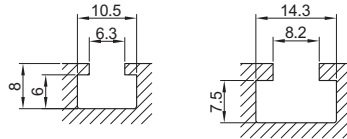

ATS05-25-19

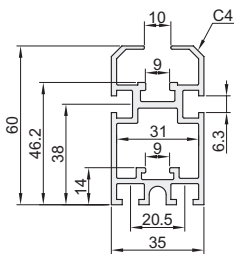

ATS05-25-19D

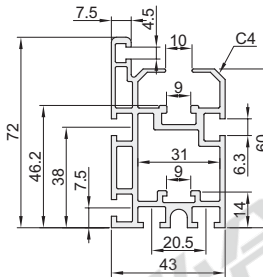

ATS05-25-25

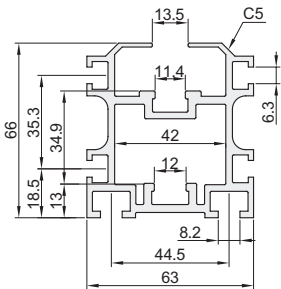

ATS05-25-25D

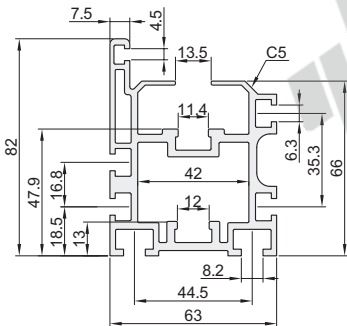

ATS06-SE148C

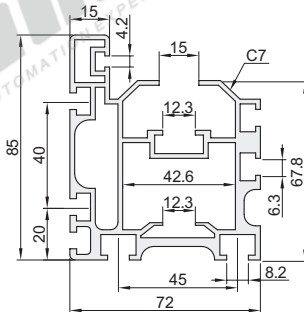

ATS05-25-31

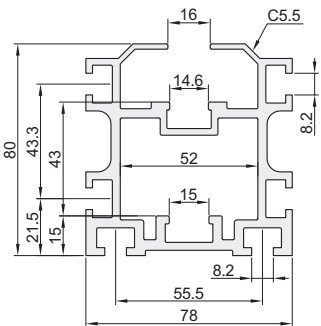

ATS05-25-31D

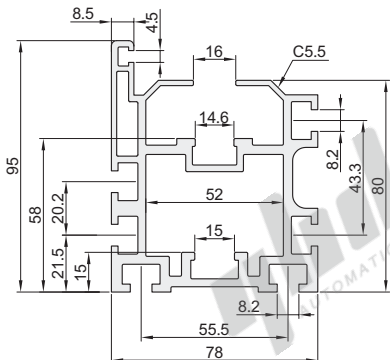

ATS05-25-31DG (此型号需另外采购钢轨)

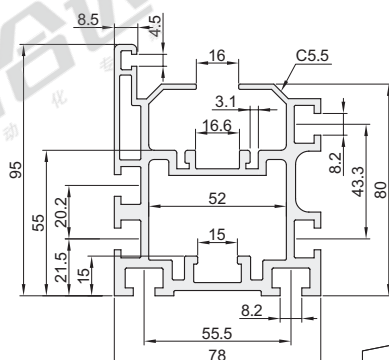

视角标准：第一视角

倍速链系列铝合金型材

ATS05-25-38

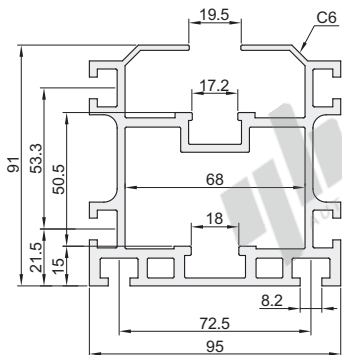

ATS05-25-38D

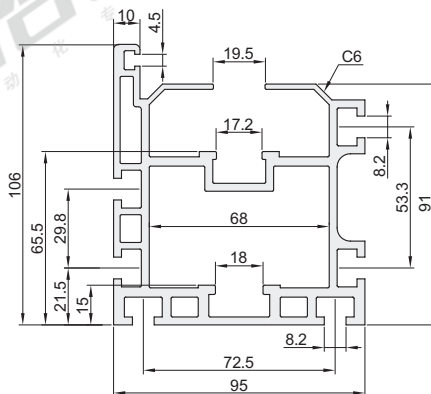

ATS05-25-38DG (此型号需另外采购钢轨)

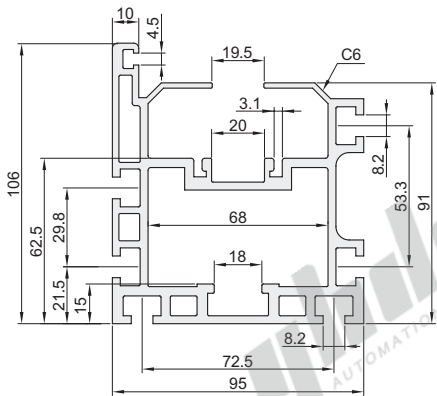

ATS05-25-50

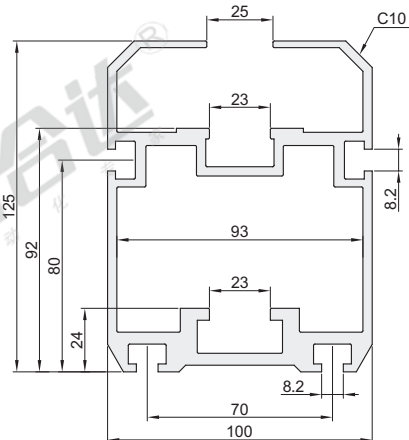

ATS05-25-50D

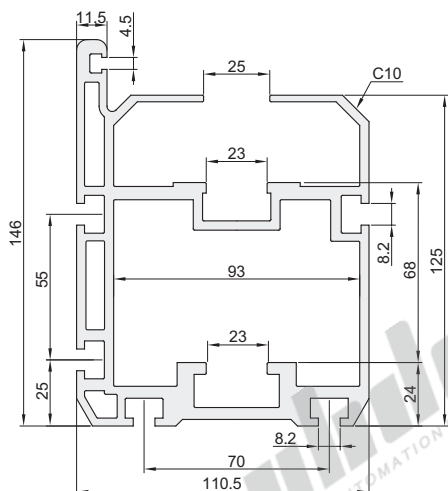

ATS05-25-50DG (此型号需另外采购钢轨)

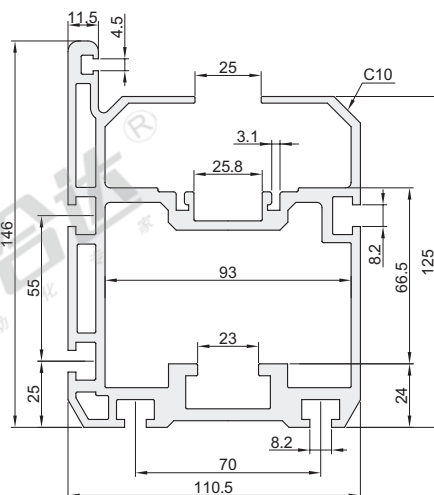

链
轮
条

F7

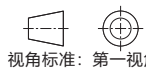

视角标准：第一视角

倍速链系列铝合金型材

ATS05-30-19

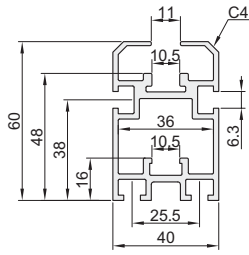

ATS05-30-19D

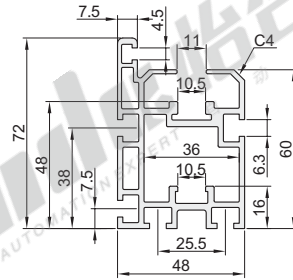

ATS05-30-25D

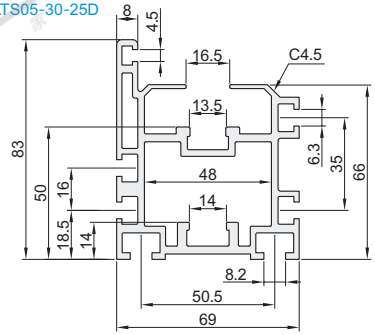

ATS05-30-31D

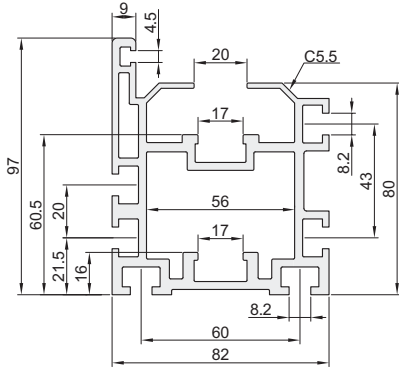

ATS05-30-31DG (此型号需另外采购钢轨)

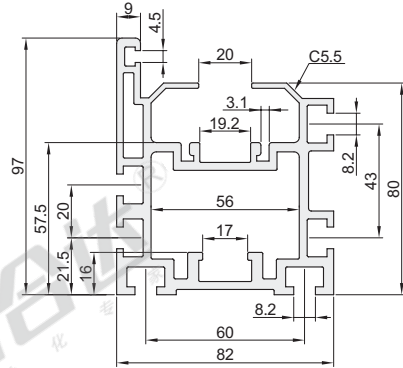

ATS05-30-38

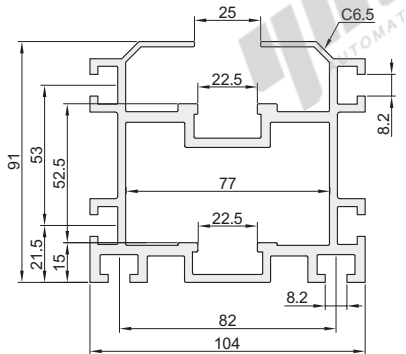

ATS05-30-38D

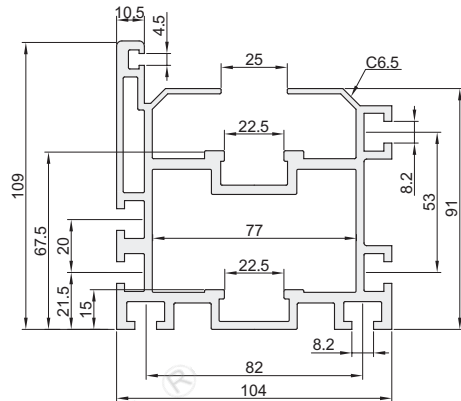

ATS05-30-38DG (此型号需另外采购钢轨)

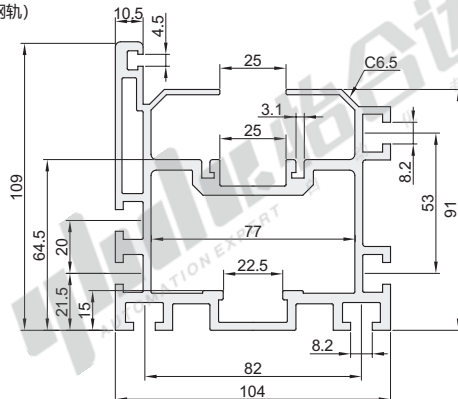

链条

F7

倍速链系列铝合金型材

ATS05-GG-L2000

倍速链钢轨
钢轨与DG系列倍速链型材
配套使用。

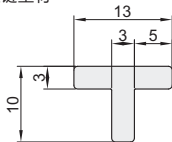

AVF61-BSL-L2000

(摩擦条)

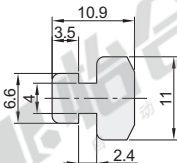

倍速链型材配件

代码	类型	材质	表面处理/颜色
ATS05-GG-L2000	钢轨	Q235	镀锌
AVF61-BSL-L2000	摩擦条	PVC	浅灰色

① 产品最大长度2m/条，可切割加工来图定制。

② 此款摩擦条适用于ATS06-SE148C以外所有带挡边型材。

EX

Example
使用示例

钢轨型材 (DG) 使用示例

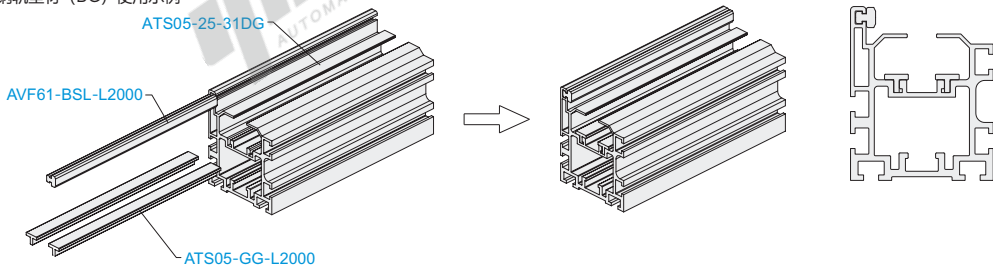

代码	倍速	规格	型号	最小单位0.5	截面尺寸	每米重量 kg/m (理论值)	截面积 (mm ²)	截面惯性矩		抗弯截面模数		适用链条 型号	适用链条 类型	
								I_x	I_y	$W_{xmax}(mm^3)$	$W_{ymax}(mm^3)$			
ATS05	25	19			35×60	1.50	543.08	17.56×10^4	8.22×10^4	5480.39	4699.31	BS25-C206B	2.5倍速 19.05节距	
		19D			43×72	1.97	715.79	28.82×10^4	15.67×10^4	6958.42	6659.43			
		25			63×66	2.73	991.65	41.09×10^4	41.30×10^4	11328.61	13111.05	BS25-C208A	2.5倍速 25.4节距	
		25D			63×82	3.12	1133.04	54.91×10^4	51.90×10^4	11174.77	15071.89			
ATS06	—	SE148C			72×85	3.32	1207.06	74.39×10^4	73.48×10^4	15110.04	18699.23			
		31			78×80	4.12	1495.61	93.22×10^4	100.26×10^4	20627.97	25707.08			
		31D			78×95	4.46	1622.27	115.49×10^4	116.10×10^4	20136.38	27729.79	BS25-C210A	2.5倍速 31.75节距	
		31DG			78×95	4.48	1627.63	114.16×10^4	116.91×10^4	19813.37	27930.71			
ATS05	25	38			95×91	5.02	1824.85	158.52×10^4	181.83×10^4	30162.56	38279.18			
		38D			95×106	5.56	2019.66	197.32×10^4	216.94×10^4	30926.36	41881.68	BS25-C212A	2.5倍速 38.1节距	
	38DG			95×106	5.66	2056.60	195.69×10^4	218.89×10^4	30620.86	42321.35				
	50	50~6000		100×125	6.92	2516.73	414.73×10^4	311.17×10^4	57977.16	62234.56				
	50D			110×146	8.60	3125.60	589.86×10^4	476.72×10^4	67953.74	77683.00	BS25-C216A	2.5倍速 50.8节距		
	50DG			110×146	8.66	3146.71	586.60×10^4	479.93×10^4	67426.85	78191.49				
	19	—	19			40×60	1.68	610.82	20.19×10^4	11.75×10^4	6472.29	5872.25	BS30-C206B	3.0倍速 19.05节距
			19D			48×72	2.15	781.31	31.25×10^4	21.26×10^4	7618.67	8205.14		
	30	—	25D			69×83	3.23	1173.90	61.22×10^4	64.69×10^4	12300.20	16874.09	BS30-C208A	3.0倍速 25.4节距
			31D			82×97	4.73	1718.00	128.74×10^4	135.92×10^4	22077.58	30186.53	BS30-C210A	3.0倍速 31.75节距
31DG					82×97	4.76	1730.72	127.53×10^4	137.15×10^4	21802.87	30478.49			
38					104×91	5.12	1859.47	155.69×10^4	225.07×10^4	30852.26	43283.47			
38D					104×109	5.79	2103.20	203.64×10^4	275.63×10^4	31724.08	47847.71	BS30-C212A	3.0倍速 38.1节距	
38DG					104×109	5.85	2127.03	202.53×10^4	277.83×10^4	31409.90	48283.27			

③ ATS06-SE148C型材槽口与其他规格不一致，可选用标准的M6/M8六角螺母。



请按图示订货

型号		L	截面尺寸
代码	倍速 规格		
ATS05	25 19 (D)	50~6000	35×60 43×72

ATS05—25—19—L150

ATS05-25-50 (D) (DG)

