

T型螺栓

代码	类型	材质	表面处理
AIC21-4010	T型螺栓	碳钢	镀锌
AIC22-4010			镀镍
AIC23-4010			镀铬

型材专用后装螺栓，使用方便快捷。

- AIC21-4010-M8-L20
- AIC21-4010-M8-L25
- AIC21-4010-M8-L30
- AIC21-4010-M8-L35
- AIC21-4010-M8-L40
- AIC22-4010-M8-L20
- AIC22-4010-M8-L25
- AIC22-4010-M8-L30
- AIC22-4010-M8-L35
- AIC22-4010-M8-L40
- AIC23-4010-M8-L20
- AIC23-4010-M8-L25
- AIC23-4010-M8-L30
- AIC23-4010-M8-L35
- AIC23-4010-M8-L40

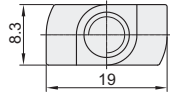
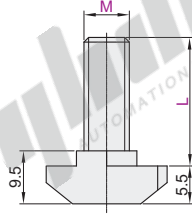

代码	重量(g/pcs)
AIC21-4010-M8-L20	13.0
AIC21-4010-M8-L25	14.4
AIC21-4010-M8-L30	16.2
AIC21-4010-M8-L35	19.0
AIC21-4010-M8-L40	19.5
AIC22-4010-M8-L20	13.0
AIC22-4010-M8-L25	14.4
AIC22-4010-M8-L30	16.2
AIC22-4010-M8-L35	19.0
AIC22-4010-M8-L40	19.5
AIC23-4010-M8-L20	13.0
AIC23-4010-M8-L25	14.4
AIC23-4010-M8-L30	16.2
AIC23-4010-M8-L35	19.0
AIC23-4010-M8-L40	19.5

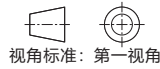

EX Example 使用示例

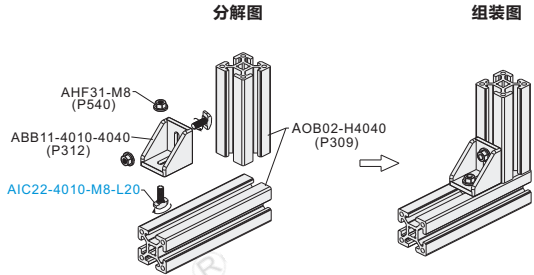

大头螺栓

代码	类型	材质	表面处理
AIL21-4010	大头螺栓	碳钢	镀锌

型材与型材90°连接。

AIL21-4010-M12-L30

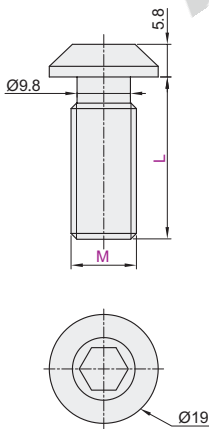

代码	重量(g/pcs)
AIL21-4010-M12-L30	27.5



EX Example 使用示例

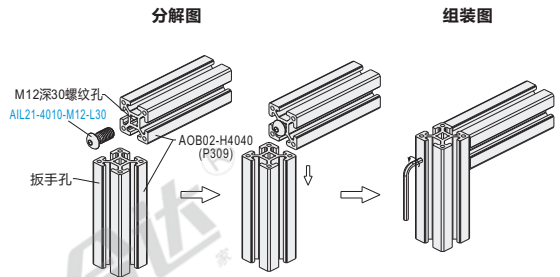

追加加工扳手柄：

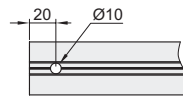

追加加工代码详见P572页。



型号
AIC22-4010-M8-L20
AIC22-4010-M8-L25

欧标45系列型材用配件-紧固部分

◀ 专用螺栓

□ T型螺栓

代码	类型	材质	表面处理
AIC21-4010	T型螺栓	碳钢	镀锌
AIC22-4010			镀镍
AIC23-4010			镀铬

① 型材专用后装螺栓，使用方便快捷。

- AIC21-4010-M8-L20
- AIC21-4010-M8-L25
- AIC21-4010-M8-L30
- AIC21-4010-M8-L35
- AIC21-4010-M8-L40
- AIC22-4010-M8-L20
- AIC22-4010-M8-L25
- AIC22-4010-M8-L30
- AIC22-4010-M8-L35
- AIC22-4010-M8-L40
- AIC23-4010-M8-L20
- AIC23-4010-M8-L25
- AIC23-4010-M8-L30
- AIC23-4010-M8-L35
- AIC23-4010-M8-L40

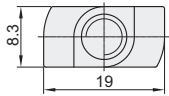
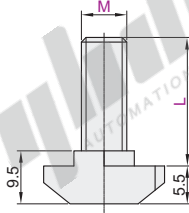

代码	重量(g/pcs)
AIC21-4010-M8-L20	13.0
AIC21-4010-M8-L25	14.4
AIC21-4010-M8-L30	16.2
AIC21-4010-M8-L35	19.0
AIC21-4010-M8-L40	19.5
AIC22-4010-M8-L20	13.0
AIC22-4010-M8-L25	14.4
AIC22-4010-M8-L30	16.2
AIC22-4010-M8-L35	19.0
AIC22-4010-M8-L40	19.5
AIC23-4010-M8-L20	13.0
AIC23-4010-M8-L25	14.4
AIC23-4010-M8-L30	16.2
AIC23-4010-M8-L35	19.0
AIC23-4010-M8-L40	19.5



视角标准：第一视角



EX

Example
使用示例

分解图

组装图

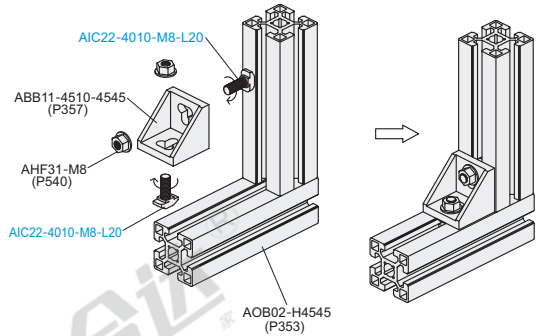

□ 大头螺栓

代码	类型	材质	表面处理
AIL21-4510	大头螺栓	碳钢	镀锌

- ① 型材与型材间90°连接。
- ② 适用于AOB02系列。

AIL21-4510-M14-L30

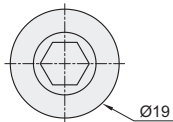
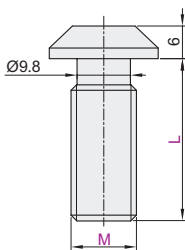

代码	重量(g/pcs)
AIL21-4510-M14-L30	35



视角标准：第一视角



EX

Example
使用示例

分解图

组装图

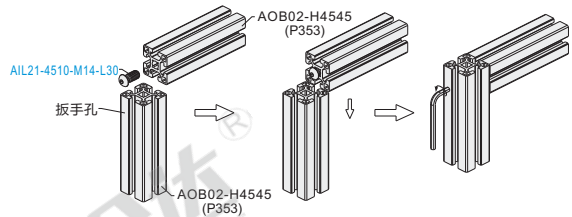

□ 追加加工扳手孔：

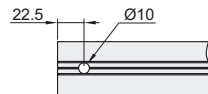

□ 追加加工代码详见P572。



请按图示订货

型号
AIC22-4010-M8-L20
AIC22-4010-M8-L25

T型螺栓

代码	类型	材质	表面处理
AIC21-4010	T型螺栓	碳钢	镀锌
AIC22-4010			镀镍
AIC23-4010			镀铬

型材专用后装螺栓，使用方便快捷。

- AIC21-4010-M8-L20
- AIC21-4010-M8-L25
- AIC21-4010-M8-L30
- AIC21-4010-M8-L35
- AIC21-4010-M8-L40
- AIC22-4010-M8-L20
- AIC22-4010-M8-L25
- AIC22-4010-M8-L30
- AIC22-4010-M8-L35
- AIC22-4010-M8-L40
- AIC23-4010-M8-L20
- AIC23-4010-M8-L25
- AIC23-4010-M8-L30
- AIC23-4010-M8-L35
- AIC23-4010-M8-L40

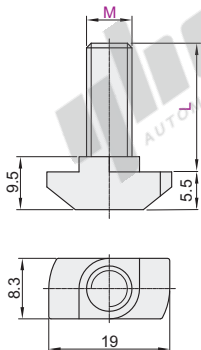

代码			重量(g/pcs)
AIC21-4010-M8-L20	AIC22-4010-M8-L20	AIC23-4010-M8-L20	13.0
AIC21-4010-M8-L25	AIC22-4010-M8-L25	AIC23-4010-M8-L25	14.4
AIC21-4010-M8-L30	AIC22-4010-M8-L30	AIC23-4010-M8-L30	16.2
AIC21-4010-M8-L35	AIC22-4010-M8-L35	AIC23-4010-M8-L35	19.0
AIC21-4010-M8-L40	AIC22-4010-M8-L40	AIC23-4010-M8-L40	19.5



EX

Example
使用示例

分解图

组装图

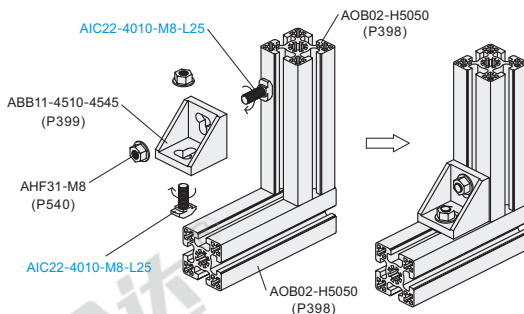

视角标准：第一视角

大头螺栓

代码	类型	材质	表面处理
AIL21-4510	大头螺栓	碳钢	镀锌

用于型材与型材90度连接。

AIL21-4510-M14-L30

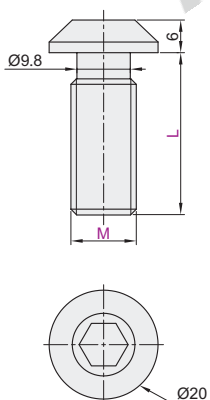

代码	重量(g/pcs)
AIL21-4510-M14-L30	35



EX

Example
使用示例

分解图

组装图

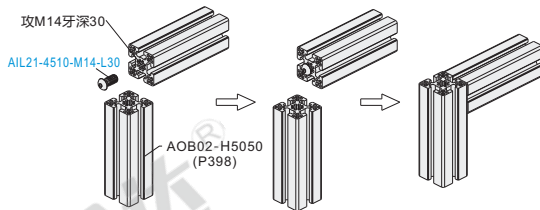

追加工扳手孔：

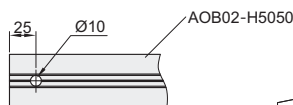

追加工代码详见P572页。

视角标准：第一视角



请按图示订货

型号
AIC22-4010-M8-L20
AIL21-4510-M14-L30