

风扇

轴流风扇 · AC型 经济型

散热风扇

代码	类型	材质	轴承	预期寿命
ZHJ07	轴流风扇	AC型	PBT	50000H(25°C)

CE



外形尺寸：80

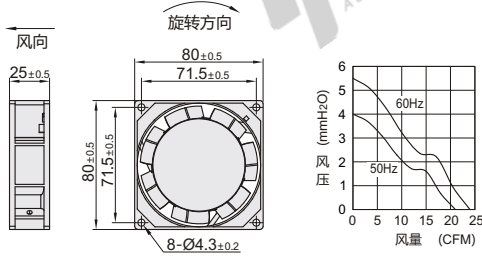

外形尺寸：92

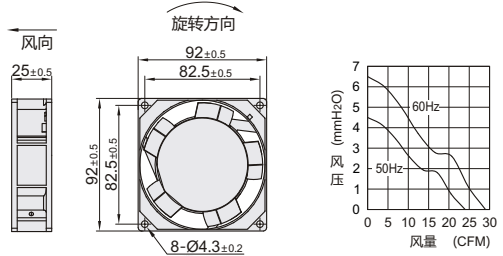

外形尺寸：120B

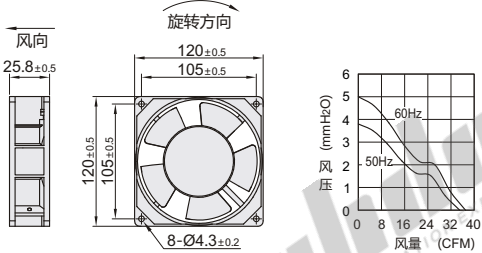

外形尺寸：120

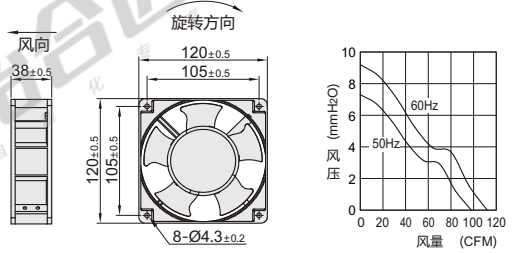

外形尺寸：150

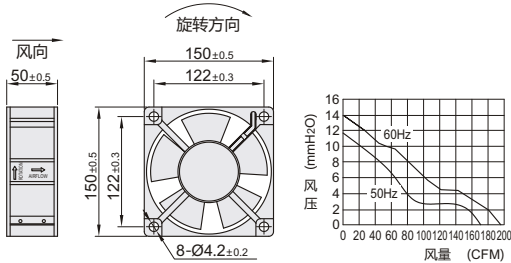

外形尺寸：172

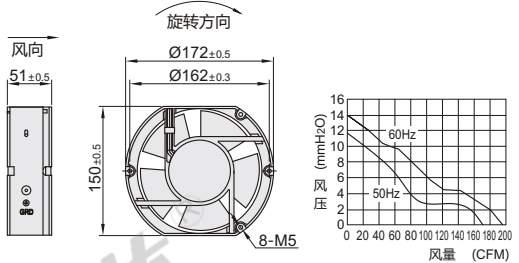

外形尺寸：200

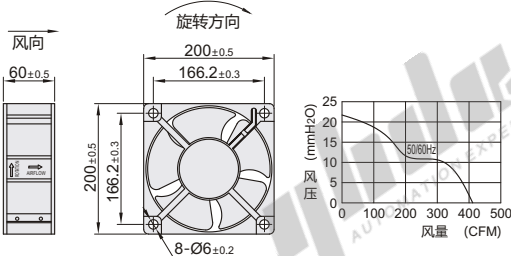

外形尺寸：220

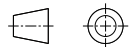
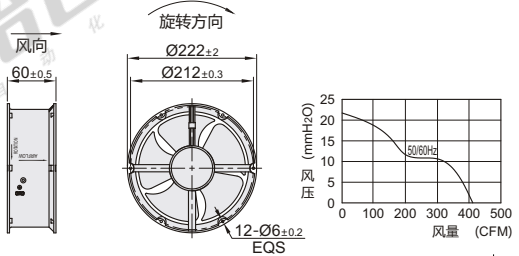

视角标准：第一视角

外形尺寸: 225

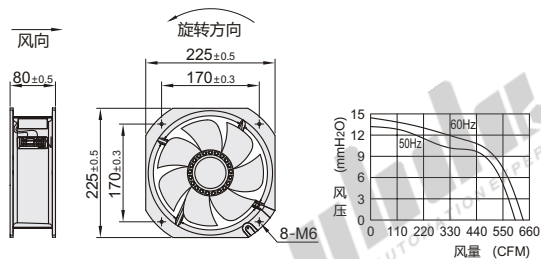

外形尺寸: 254

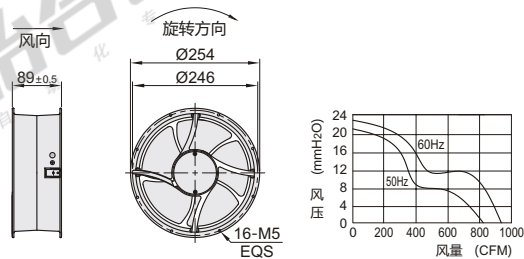

外形尺寸: 280

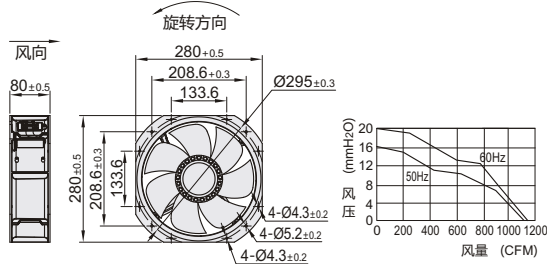

外形尺寸: 340

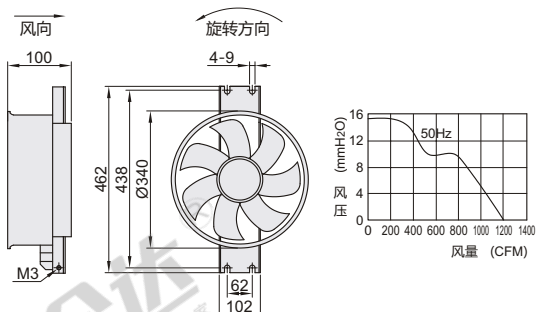

视角标准: 第一视角

型号	代码	外形尺寸	适配附件	长×宽×高 (mm)	输入电压	频率 (Hz)	功率 (W)	电流 (A)	转速 (RPM)	风量 (CFM)	风压 (mm-H ₂ O)	噪音 (Db[A])	重量 (g)		
ZHJ07	80			80×80×25	AC220/240V	50/60	16/12	0.08/0.07	2550/2900	25/29	3.31/4.44	34/37.2	210		
	92			92×92×25			18/16	0.11/0.1	2100/2200	36/37.71	2.2/2.41	35/36	275		
	120B			120×120×25			18/16	0.13/0.11	2650/2950	85/98	6.4/7	45/48	432		
	120			120×120×38											
	150		防护网ZHJ42	150×150×50					38/36	0.25/0.23	2600/2300	168/149	10.5/9.2	48/45	830
	172		过滤网ZHJ41	172×150×51											850
	200		或	200×200×60					45/48	0.32/0.35	2600/3000	400/470	13.0/15.2	61/65	1500
	220		百叶窗ZHJ43	Ø222×60					75/85	0.32/0.4	2600/2800	560/680	16.5/20.0	60/64	2100
	225			225×225×80					50/65	0.22/0.28	2750/3000	750/920	17.2/19.5	58/62	2000
	254			Ø254×89					100/120	0.45/0.5	2600/2800	1059/1130	16.5/20.0	68/70	2800
280			280×280×80			340									
340			462×102×100			50	150	0.5	2200	1240	11.5	73	3550		

① 适用配件防护网/过滤网详见P254, 百叶窗详见P256.



请按图示订货

型号	
代码	外形尺寸
ZHJ07	80
	92

ZHJ07-80