

挤压角座

代码	类型	材质	表面处理
ABC01-206	挤压角座	A6063-T5	喷砂氧化
ABC02-206			喷砂氧化(断面、打孔处无氧化)
ABC03-206			黑色喷砂氧化



- ① 用于型材固定角度的外连接，可固定封板。
- ② 根据设计需求，孔距、长度可来图加工。
- ③ 此系列挤压角座不适用于AOB05-2550。
- ④ ABC02系列产品表面有轻微划伤属于正常现象。

ABC01-206-20-14
ABC02-206-20-14
ABC03-206-20-14

ABC01-206-20-34
ABC02-206-20-34
ABC03-206-20-34

ABC01-206-20-54
ABC02-206-20-54
ABC03-206-20-54

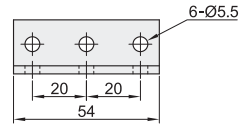
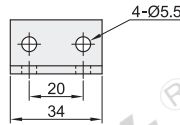
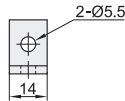
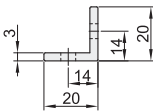

ABC01-206-20-15
ABC02-206-20-15
ABC03-206-20-15

ABC01-206-20-35
ABC02-206-20-35
ABC03-206-20-35

ABC01-206-20-55
ABC02-206-20-55
ABC03-206-20-55

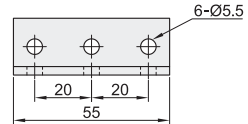
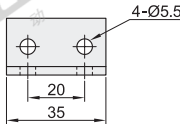
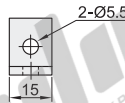
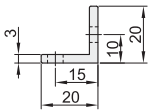

ABC01-206-35-14
ABC02-206-35-14
ABC03-206-35-14

ABC01-206-35-34
ABC02-206-35-34
ABC03-206-35-34

ABC01-206-35-54
ABC02-206-35-54
ABC03-206-35-54

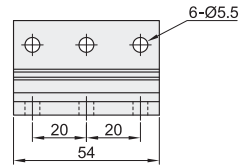
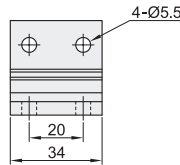
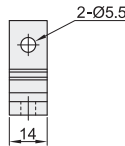
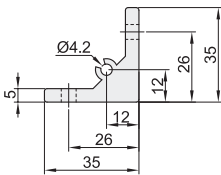

ABC01-206-55-14
ABC02-206-55-14
ABC03-206-55-14

ABC01-206-55-34
ABC02-206-55-34
ABC03-206-55-34

ABC01-206-55-54
ABC02-206-55-54
ABC03-206-55-54

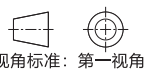
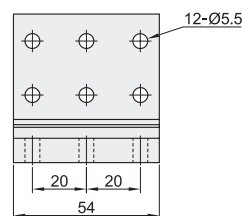
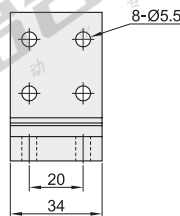
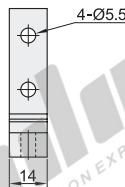
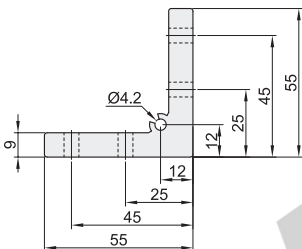

欧标20系列型材用配件-连接部分

挤压角座

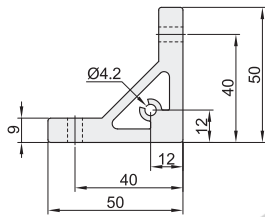

ABC01-206-50-14
ABC02-206-50-14
ABC03-206-50-14

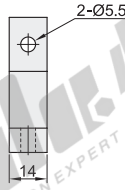

ABC01-206-50-34
ABC02-206-50-34
ABC03-206-50-34

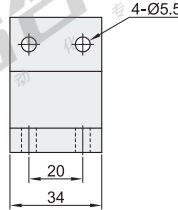

ABC01-206-50-54
ABC02-206-50-54
ABC03-206-50-54

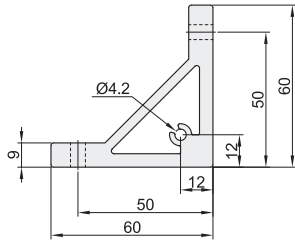
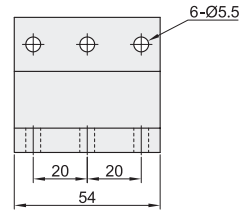

ABC01-206-60-14
ABC02-206-60-14
ABC03-206-60-14

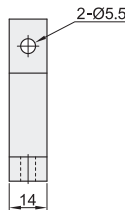

ABC01-206-60-34
ABC02-206-60-34
ABC03-206-60-34

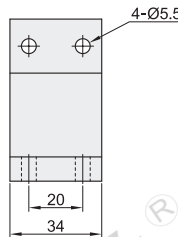

ABC01-206-60-54
ABC02-206-60-54
ABC03-206-60-54

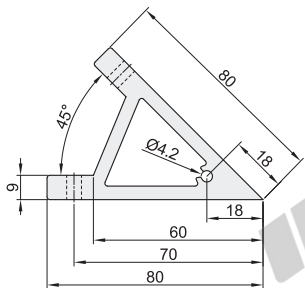
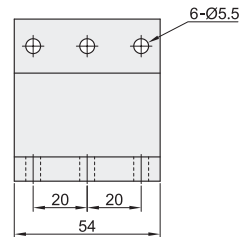

ABC01-206-80A-14
ABC02-206-80A-14
ABC03-206-80A-14



ABC01-206-80A-34
ABC02-206-80A-34
ABC03-206-80A-34

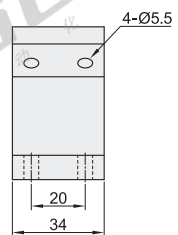

ABC01-206-80A-54
ABC02-206-80A-54
ABC03-206-80A-54

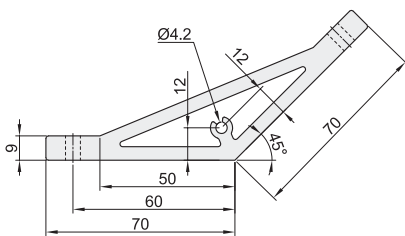
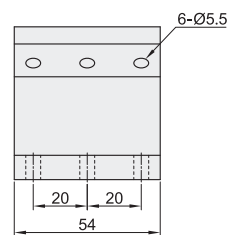

ABC01-206-70-14
ABC02-206-70-14
ABC03-206-70-14

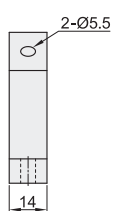

ABC01-206-70-34
ABC02-206-70-34
ABC03-206-70-34

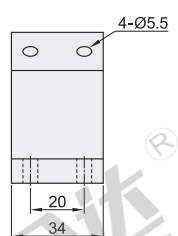

ABC01-206-70-54
ABC02-206-70-54
ABC03-206-70-54

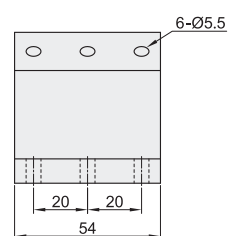

视角标准：第一视角

代码			重量 (g/pcs)	代码			重量 (g/pcs)
ABC01-206-20-14	ABC02-206-20-14	ABC03-206-20-14	3.4	ABC01-206-50-14	ABC02-206-50-14	ABC03-206-50-14	28
ABC01-206-20-34	ABC02-206-20-34	ABC03-206-20-34	8.9	ABC01-206-50-34	ABC02-206-50-34	ABC03-206-50-34	69
ABC01-206-20-54	ABC02-206-20-54	ABC03-206-20-54	13.5	ABC01-206-50-54	ABC02-206-50-54	ABC03-206-50-54	109
ABC01-206-20-15	ABC02-206-20-15	ABC03-206-20-15	4.1	ABC01-206-60-14	ABC02-206-60-14	ABC03-206-60-14	34
ABC01-206-20-35	ABC02-206-20-35	ABC03-206-20-35	9.7	ABC01-206-60-34	ABC02-206-60-34	ABC03-206-60-34	82
ABC01-206-20-55	ABC02-206-20-55	ABC03-206-20-55	15.3	ABC01-206-60-54	ABC02-206-60-54	ABC03-206-60-54	129
ABC01-206-35-14	ABC02-206-35-14	ABC03-206-35-14	14.4	ABC01-206-80A-14	ABC02-206-80A-14	ABC03-206-80A-14	40.5
ABC01-206-35-34	ABC02-206-35-34	ABC03-206-35-34	35.2	ABC01-206-80A-34	ABC02-206-80A-34	ABC03-206-80A-34	96
ABC01-206-35-54	ABC02-206-35-54	ABC03-206-35-54	56	ABC01-206-80A-54	ABC02-206-80A-54	ABC03-206-80A-54	152
ABC01-206-55-14	ABC02-206-55-14	ABC03-206-55-14	32	ABC01-206-70-14	ABC02-206-70-14	ABC03-206-70-14	46.6
ABC01-206-55-34	ABC02-206-55-34	ABC03-206-55-34	77	ABC01-206-70-34	ABC02-206-70-34	ABC03-206-70-34	116
ABC01-206-55-54	ABC02-206-55-54	ABC03-206-55-54	122	ABC01-206-70-54	ABC02-206-70-54	ABC03-206-70-54	185

EX

Example
使用示例

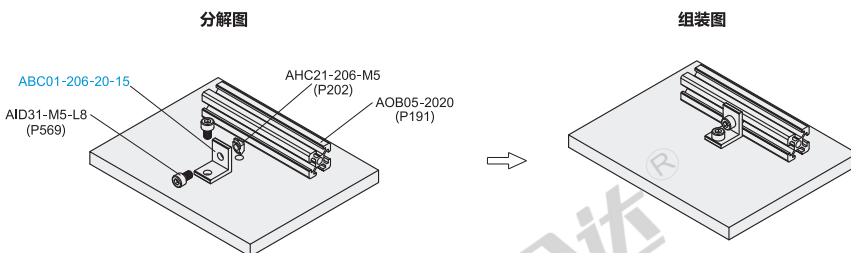
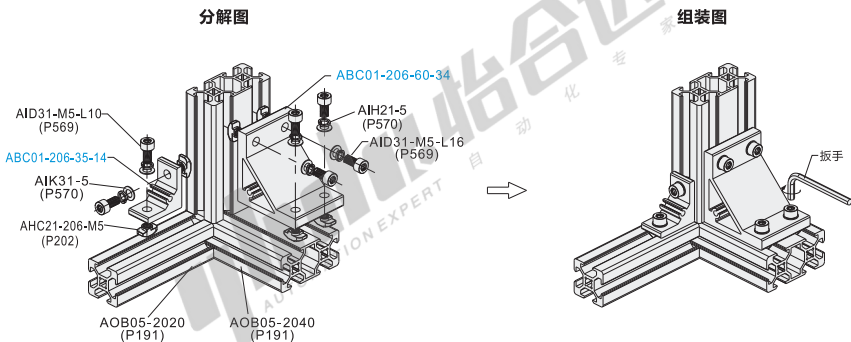

请按图示订货

型号
ABC01-206-70-14
ABC01-206-70-34

可选加工

型号	可选加工代码
ABC01-206-70-14	S
ABC01-206-70-34	SET-OB
ABC01-206-70-14-S	



可选加工

型号	可选加工代码
ABC01-206-70-14	S
ABC01-206-70-34	SET-OB
ABC01-206-70-14-S-SET-OB	

① ABC01-206-20-14、ABC01-206-20-34、ABC01-206-20-54、ABC01-206-20-15、ABC01-206-20-35、ABC01-206-20-55、ABC02-206-20-14、ABC02-206-20-34、ABC02-206-20-54、ABC02-206-20-15、ABC02-206-20-35、ABC02-206-20-55、ABC03-206-20-14、ABC03-206-20-34、ABC03-206-20-54、ABC03-206-20-15、ABC03-206-20-35、ABC03-206-20-55 不提供螺纹孔加工。

增加加工项目	代码	技术说明
面板安装 螺纹孔加工	S	在角座侧面上加工安装面板用的螺纹孔(单面M5螺纹孔深度15mm)。 螺纹孔位置
配备合适的 螺栓、T型螺母、 垫片和弹垫	SET-OB	指定SET时, 配备将角座固定在型材上的螺栓、T型螺母、垫片。(例) 螺栓: AID31-M5-L10 T型螺母: AHC21-206-M5 垫片: AIK31-5 弹垫: AIH21-5
配备合适 螺栓、螺母	HSET	指定HSET时, 配备将角座固定在型材上的螺栓、螺母。(例) 螺栓: AID21-M5-L8 螺母: AHN21-206-M5
配备不锈钢 螺栓、螺母	HSST	指定HSST时, 配备将角座固定在型材上的不锈钢螺栓、螺母。(例) 螺栓: AID31-M5-L8 螺母: AHN31-206-M5
配备螺栓、弹 珠滑块螺母	HSEU	指定HSEU时, 配备将角座固定在型材上的螺栓、弹珠滑块螺母。(例) 螺栓: AID21-M5-L8 螺母: AHB21-206-M5
配备螺栓、后 装弹珠螺母	HSEP	指定HSEP时, 配备将角座固定在型材上的螺栓、后装弹珠螺母。(例) 螺栓: AID21-M5-L8 螺母: AHJ21-206-M5
配备带垫圈 螺栓、螺母	HSEC	指定HSEC时, 配备将角座固定在型材上的带垫圈螺栓、螺母。(例) 螺栓: AID21-ZH-M5-L10 螺母: AHN21-206-M5

- ① 备注: 根据不同的角座厚度配备不同规格的螺栓。
- ② 备注: ABC03-206不适用SET-OB可选加工。
- ③ 备注: 显示螺栓型号仅供参考, 不同的下单型号将配备不同长度和不同数量的螺栓、螺母。
ABC03-206不适用于HSST, HSEC可选加工;
ABC03-206配备发黑处理的螺栓AID27。