

柔性夹爪配件

滑移安装板

代码	类型	
NIL81	柔性夹爪配件	滑移安装板

产品特点:

- 按形状和槽长度分为不同款式;
- 柔指模块NIL21的安装角度和位置可自由调节。

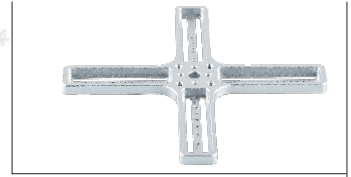

规格: 02(两向)
尺寸: S(短款)

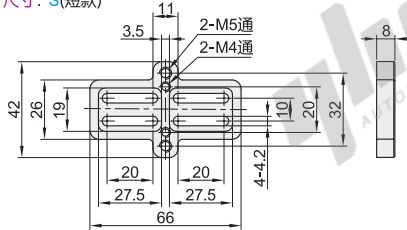

规格: 02(两向)
尺寸: L(长款)

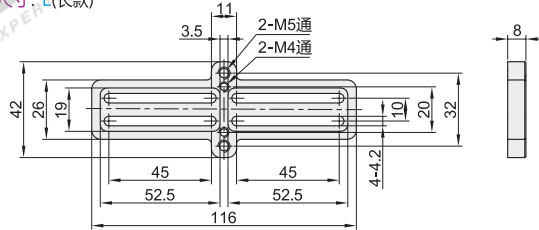

规格: 03(三向)
尺寸: S(短款)

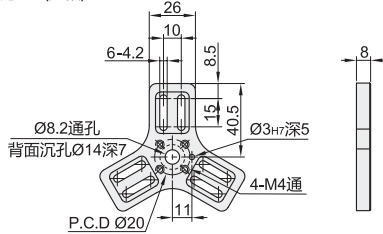

规格: 03(三向)
尺寸: L(长款)

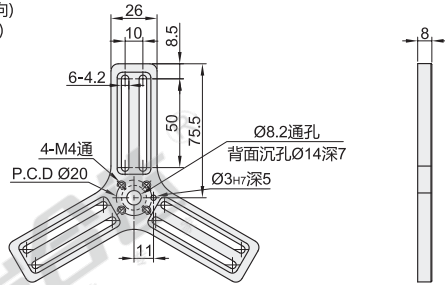

规格: 04(四向)
尺寸: S(短款)

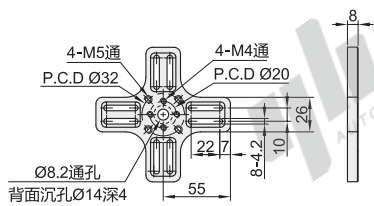

规格: 04(四向)
尺寸: L(长款)

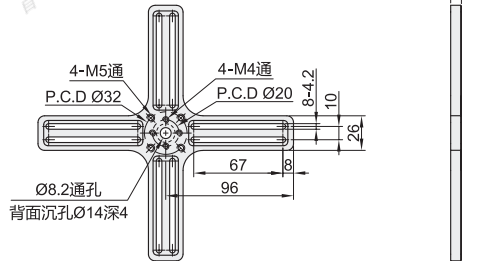

规格: 05(五向)
尺寸: S(短款)

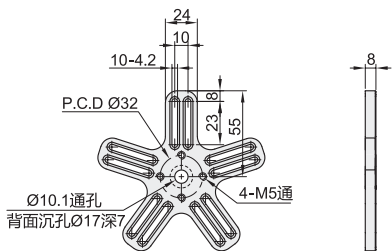

规格: 05(五向)
尺寸: L(长款)

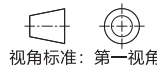
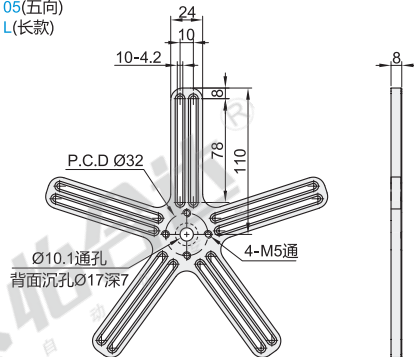

视角标准: 第一视角

型号	规格	尺寸	重量(g)	适配柔指模块代码
NIL81	02(两向)	S(短款)	18.2	NIL21
		L(长款)	28.2	
	03(三向)	S(短款)	34.6	
		L(长款)	54.1	
	04(四向)	S(短款)	55	
L(长款)		89.5		
05(五向)	S(短款)	95.4		
	L(长款)	181		



请按图示订货

代码	规格	尺寸
NIL81	02(两向)	S(短款) L(长款)

NIL81 — 02 — S



未税价(元)

● 优惠价

数量	1~10	11~
价格	100%	另行报价

交货期	7
-----	---