

# MS-T系列交流接触器 MS-T系列辅助触头

三菱品牌

CCC CE



## MS-T系列交流接触器

### 特点

- MS-T系列通过使用电动机断路器和选配件（连接导体），提高了接线效率。
- 新型集成端子盖，集成端子盖系统彻底解决了上述问题，端子盖始终在电磁接触器或其辅助触头上，随时可用。
- MS-T系列辅助触头可在20V 3mA的微小负载下动作，因此特别适用于PLC输出的直接控制/操作。

### S-T10

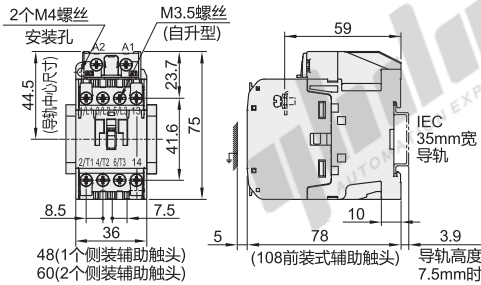

### 安装尺寸图

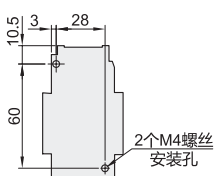

### 触头构成

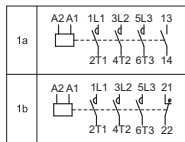

### S-T12/S-T20

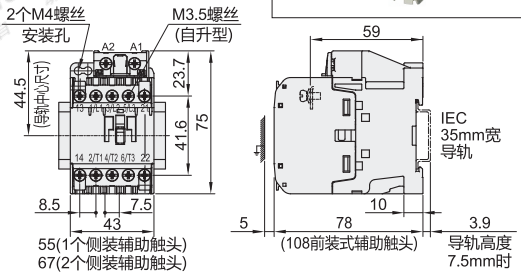

### 安装尺寸图

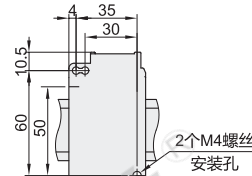

### 触头构成

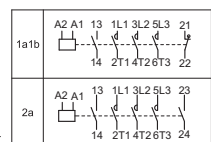

### S-T21/S-T25

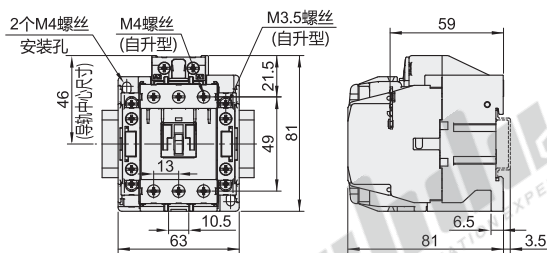

### 安装尺寸图

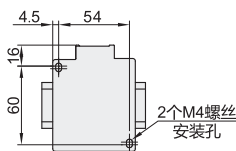

### 触头构成

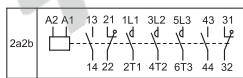

### S-T32

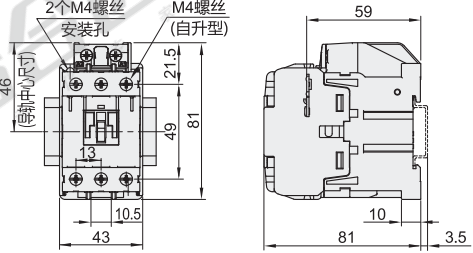

### 安装尺寸图

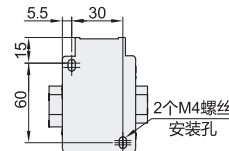

### 触头构成

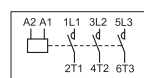

### S-T35/S-T50

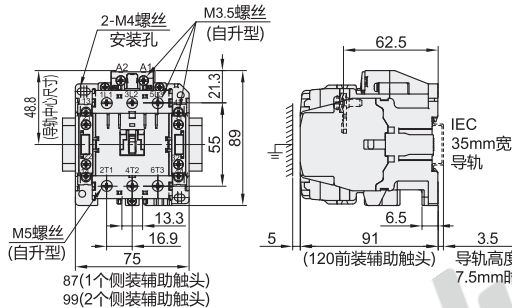

### 安装尺寸图

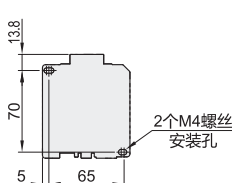

### 触头构成

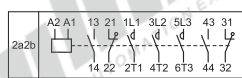

### SD-T12/SD-T20

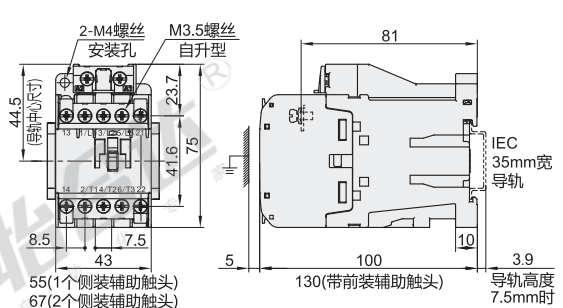

### 安装尺寸图

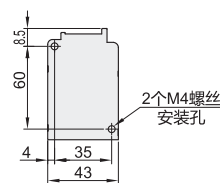

### 触头构成

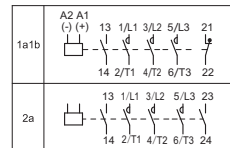

SD-T21

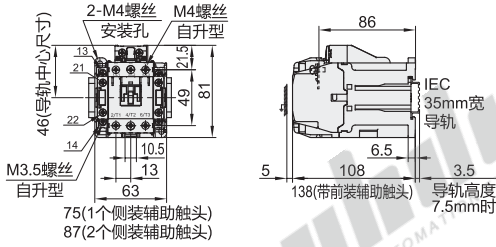

安装尺寸图

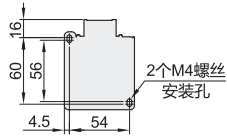

触头构成

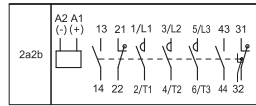

SD-T32

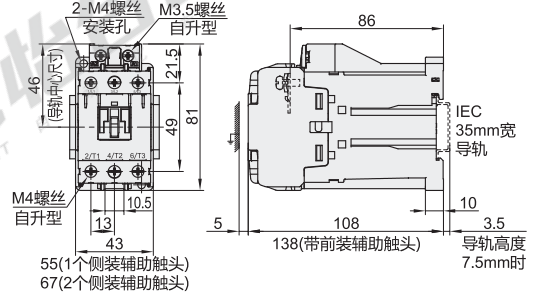

安装尺寸图

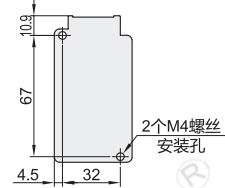

触头构成

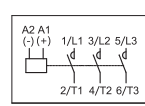

SD-T35

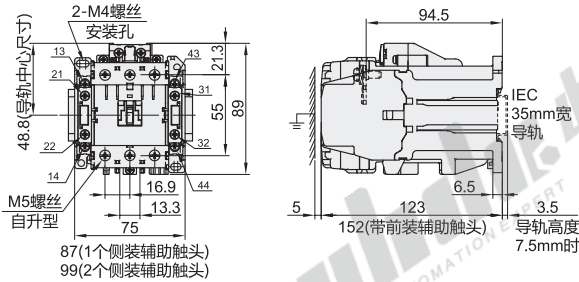

安装尺寸图

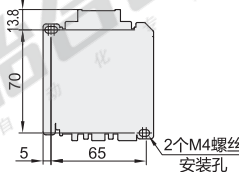

触头构成

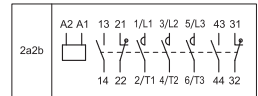

MS-T系列辅助触头

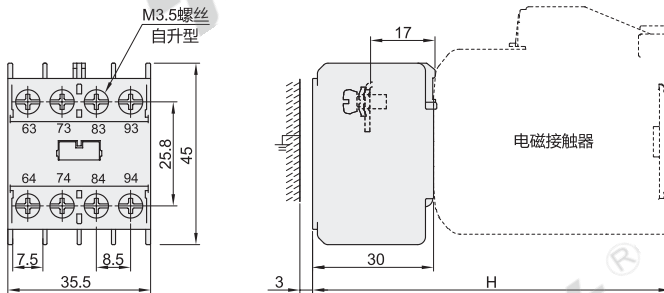

型号	H
S-T10/T12/T20	108
S-T21/T25/T32	111

视角标准：第一视角

MS-T系列交流接触器

型号	额定电流(A) (AC220~AC240V)	线圈 电压	辅助触点 类型	极数
S-T10 AC200V 1A C	9	AC200 ~ AC240V	1a	3
S-T10 AC200V 1B C			1b	
S-T12 AC200V 1A1B C	12		1a 1b	3
S-T12 AC200V 2A C			2a	
S-T20 AC200V 1A1B C	18		1a 1b	3
S-T20 AC200V 2A C			2a	
S-T21 AC200V 2A2B C	23		2a 2b	3
S-T25 AC200V 2A2B C			2a 2b	
S-T32 AC220V C	32		-	3
S-T35 AC220V 2A2B C	40		-	-
S-T50 AC220V 2A2B C	50	-	-	
SD-T12 DC24V 1A1B	12	DC24V	1a 1b	3
SD-T20 DC24V 1A1B	18		1a 1b	
SD-T21 DC24V 2A2B	23		2a 2b	
SD-T32 DC24V 2A2B	32		2a 2b	
SD-T35 DC24V 2A2B	40		2a 2b	

热过载继电器详见P178。

MS-T系列辅助触头

型号	极数	安装 方式	辅助触点 类型	适配交流 接触器
UT-AX4 2a2b	4	前装式	2a 2b	交流型：S-T10~T50 直流型：SD-T12~T35
UT-AX4 3a1b			3a 1b	
UT-AX4 4a	4a			
UT-AX2 2a	2a			
UT-AX2 2b	2b			
UT-AX11 1a1b	2		侧装式	



报价  
方式



MS-T系列交流接触器

型号
S-T10 AC200V 1A C
S-T10 AC200V 1B C
S-T10 AC200V 1A C

MS-T系列辅助触头

型号
UT-AX4 2a2b
UT-AX4 3a1b
UT-AX4 2a2b