



DC 输入侧



AC 输出侧



IEC62368-1 BS EN/EN62368-1 (for 112/124 type GFCI only) TPTC004 AS/NZS 62368.1
 详情请参阅第3页。

特性

- 采纯正弦波输出 (THD<3%)
- 瞬间功率高达3400W
- 温控冷却风扇
- 交流输出电压和频率可由DIP S.W选择
- 待机省电模式下空载消耗<1.5W max
- -25°C~+70°C宽工作温度
- 遥控开关电源
- 显示操作状态的前面板指示灯
- 保护:
 输入: 反极性/直流低压警报/直流低压关机/过压
 输出: 短路/过载/过温。
- 电池过放电保护(低压断开)
- 适用于铅酸电池或锂离子电池
- 遥控器
 (IRC1, IRC2, IRC3配件单独销售,请参阅: <http://www.meanwell.cc/webapp/product/search.aspx?prod=IRC1>)
- 支持RS-232通讯(通讯线订单号: RJ11-RS232,单独销售)
- 提手配件(订单号: Carry handle, 单独销售)
- 保护涂层
- 3年长效保固

应用

- 家居办公用品
- 电动工具
- 便携设备
- 车辆
- 游艇
- 离网太阳能发电系统
- 无线网络
- 电信或数据通讯系统

描述

NTS-1700是一款1700W高信赖离网纯正弦波DC-AC逆变器。其主要功能包括：单片机控制的数字设计、快速响应工况变化的新型控制电路、可靠性高、低噪音的高品质风扇、3400W峰值功率、交流输出电压和频率可调、-25~+70°C宽工作温度范围、完整的保护功能等等。结合电池，NTS-1700适用于住宅、商业、船舶、汽车、矿山、建筑工地和没有公用电源设施的偏远地区，输出可用于风扇、电视、收音机、手机充电器、笔记本电脑、照明、电磁炉、空调、机电工具、通讯设备、配电柜、户外露营设备、船舶交流电源、工厂设备等。

型号编码

NTS - 1700 - 1 12 US

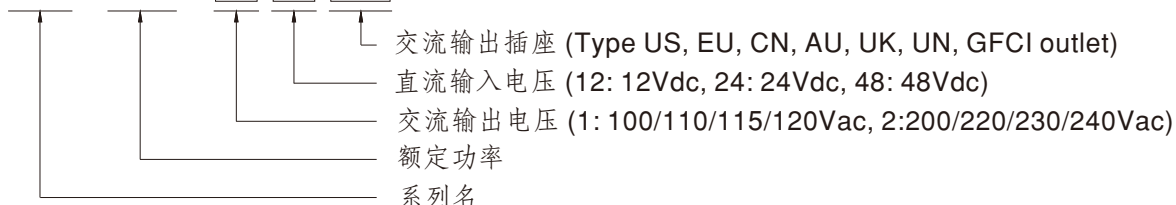

电气规格

型号		NTS-1700-112□	NTS-1700-124□	NTS-1700-148□	NTS-1700-212□	NTS-1700-224□	NTS-1700-248□		
		□ = US, GFCI, UN			□ = EU, CN, AU, UK, UN				
AC输出	额定功率(连续)	1500W			1700W				
	过功率(3分钟)	1750W			2000W				
	峰值功率(10秒)	2200W			2550W				
	瞬间功率(30周期)	3000W			3400W				
	交流电压	出厂设定在 110VAC 100 / 110 / 115 / 120Vac 可由DIP S.W选择			出厂设定在 230VAC 200 / 220 / 230 / 240Vac 可由DIP S.W选择				
	频率	出厂设定在60Hz±0.1Hz 50/60Hz 可由DIP S.W选择			出厂设定在 50Hz±0.1Hz 50/60Hz 可由DIP S.W选择				
	波形 备注1	纯正弦波 (THD<3%)							
	交流调整率	额定输出电压的±3.0%							
前面板LED	请参考第5页								
DC输入	直流电压	12Vdc	24Vdc	48Vdc	12Vdc	24Vdc	48Vdc		
	电压范围 (Typ.)	10 ~ 16.5Vdc	20 ~ 33Vdc	40 ~ 66Vdc	10 ~ 16.5Vdc	20 ~ 33Vdc	40 ~ 66Vdc		
	直流电流 (Typ.)	150A	75A	37.5A	170A	85A	42.5A		
	空载保护(省电模式) (Typ.) 备注2	默认不可用, ≤1.2W ~ 1.5W 自动检测交流输出负载 ≤10W 将切换为省电模式							
	关机模式电流	≤1mA							
	效率(Typ.) 备注1	89%	90%	91%	89%	92%	93%		
电池类型	铅酸或锂离子电池								
保护	DC输入	保险丝(内部)	40A*6	40A*3	25A*3	40A*6	40A*3	25A*3	
		低压	报警	11±0.3Vdc	22±0.5Vdc	44±1Vdc	11±0.3Vdc	22±0.5Vdc	44±1Vdc
			关机	10±0.3Vdc	20±0.5Vdc	40±1Vdc	10±0.3Vdc	20±0.5Vdc	40±1Vdc
			重启	12.5±0.3Vdc	25±0.5Vdc	50±1Vdc	12.5±0.3Vdc	25±0.5Vdc	50±1Vdc
		高压	报警	15.5±0.3Vdc	31±0.5Vdc	62±1Vdc	15.5±0.3Vdc	31±0.5Vdc	62±1Vdc
			关机	16.5±0.3Vdc	33±0.5Vdc	66±1Vdc	16.5±0.3Vdc	33±0.5Vdc	66±1Vdc
	AC输出	重启	15±0.3Vdc	30±0.5Vdc	60±1Vdc	15±0.3Vdc	30±0.5Vdc	60±1Vdc	
		电池反接	通过内部保险丝						
		过温度	保护模式:关闭输出电压, 重启后恢复						
		输出短路	保护模式:关闭输出电压, 重启后恢复						
过负载(Typ.)	负载的105~115%持续180秒, 115~150%持续10秒 保护模式:关闭输出电压, 重启后恢复								
熔断器 (仅适用于"GFCI"交流插座)	15A				10A				
GFCI防护	设计参考 UL458 (仅适用于"GFCI"交流插座)			无					
功能	遥控	干触点	前面板干触点连接器(继电器)远程控制电源开关, 开路:正常工作; 短路:遥控关闭						
	配件	遥控器单独销售, 料号: IRC2, IRC1, IRC3							
RS-232通讯	RS-232 ~ RJ11 类型连接器(详情请参阅第4页)								
环境	工作温度	-25 ~ +70°C (请参考“降额曲线”)							
	工作湿度	20 ~ 90% RH, 无冷凝							
	储存温度、湿度	-30 ~ +70°C / -22 ~ +158°F, 10 ~ 95% RH, 无冷凝							
	耐振动	10 ~ 500Hz, 3G 10分钟/周期, X、Y、Z轴各60分钟							
安规和电磁兼容 (备注5)	安全规范	CB IEC62368-1, Dekra BS EN/EN62368-1, UL458, E13, EAC TP TC 004, AS/NZS 62368.1 认证通过 (详情请参阅下一页“交流输出插座”表)							
	耐压	DC I/P - AC O/P: 3.0kVac AC O/P - FG: 1.5kVac							
	电磁干扰	Parameter	Standard				Test Level / Note		
		Radiated	FCC for 112, 124, 148 only (expect for Type-UN)				Class A		
			BS EN/EN55032 (CISPR32) for 212, 224, 248 only (expect for Type-UN)				Class A		
		Harmonic Current	BS EN/EN61000-3-2				-----		
	Voltage Flicker	BS EN/EN61000-3-3				-----			
	电磁耐受	BS EN/EN55024, BS EN/EN55035							
		Parameter	Standard				Test Level / Note		
		ESD	BS EN/EN61000-4-2				Level 3, 8KV air; Level 2, 4KV contact		
Radiated		BS EN/EN61000-4-3				Level 2, 3V/m			
Magnetic Field	BS EN/EN61000-4-8				Level 1, 1A/m				
其它	MTBF	475.5K hrs min. Telcordia TR/SR-332 (Bellcore); 46.2K hrs min. MIL-HDBK-217F (25°C)							
	尺寸	400*184*70mm (L*W*H)							
	包装	4.63Kg; 2pcs/ 12Kg/ 1.76CUFT							
备注	<p>1.效率、交流调整率和THD是在12.5V, 25V, 50V输入电压、900W线性负载条件下测得。</p> <p>2.空载保护非省电状态下: 112/124/148 for 16W, 212/224/248 for 29W。</p> <p>3.如未特别说明, 所有规格参数在额定负载, 25°C环境温度下, 设置成出厂设置的情况下进行量测。</p> <p>4.内部含有预启动线路, 开机时间8s。</p> <p>5.电源应视为一个独立的元件, 需结合终端设备进行电磁兼容相关确认。有关EMC测试操作指导, 请参阅“电源供应器EMI测试声明书”。(在明纬网站https://www.meanwell.com/Upload/PDF/EMI_statement_cn.pdf)</p> <p>※ 产品免责声明: 详情请参阅 http://www.meanwell.cc/serviceDisclaimer.aspx</p>								

交流输出插座

型号	NTS-1700-112 <input type="checkbox"/>	NTS-1700-124 <input type="checkbox"/>	NTS-1700-148 <input type="checkbox"/>	NTS-1700-212 <input type="checkbox"/>	NTS-1700-224 <input type="checkbox"/>	NTS-1700-248 <input type="checkbox"/>	
插座类型							
	TYPE-US	TYPE-GFCI	TYPE-UN	TYPE-EU	TYPE-CN	TYPE-AU	TYPE-UN
国家	有现货	可选购	有现货	有现货	有现货	可选购	可选购
国家	美国	美国	全球通用	欧洲	中国	英国	澳大利亚
认证			None				

减额曲线

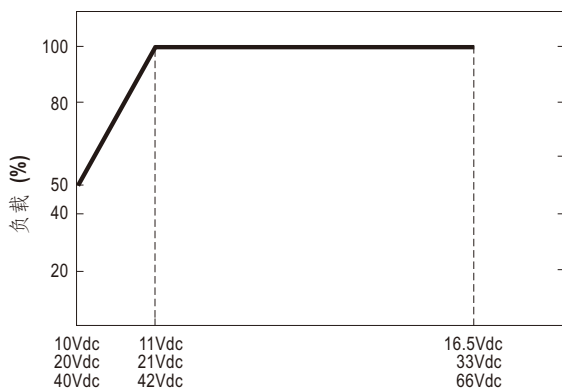
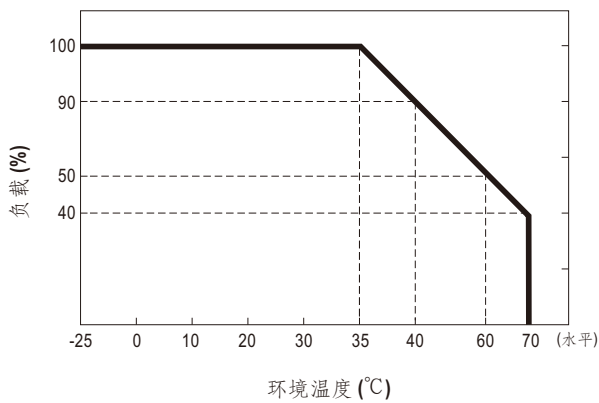

■ IRC1/2/3 远端监控 (配件需单独订购)

- IRC1/IRC2/IRC3是一款远端监控模组。
 - IRC1/IRC2/IRC3可以解码逆变器内部发送的RS-232信号通过逆变器系列并透过IRC1/IRC2/IRC3数字依表显示。
- Note: 部份远程控制器灯号会因逆变器是实际功能而无法显示灯号。

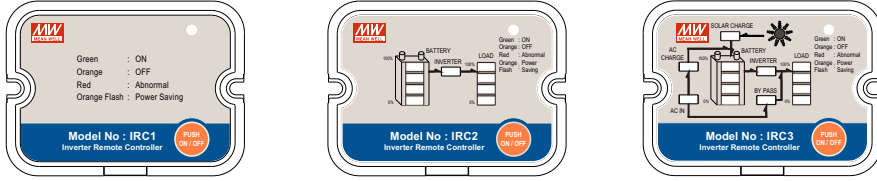

※ 详情请参阅: <http://www.meanwell.cc/webapp/product/search.aspx?prod=IRC1>

■ 支持 RS-232 通讯

- 通过RS-232通讯可以读取单台NTS-1700内部资料。

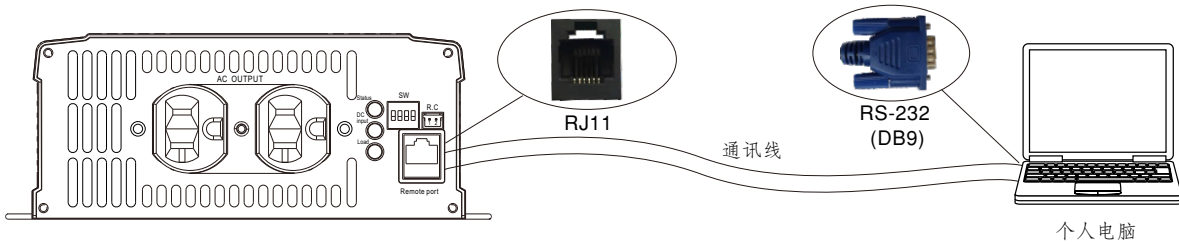

※ 详情请参阅: <http://www.meanwell.com/manual.html>

※ RJ11-RS232 通讯线需单独订购, 订单号: RJ11-RS232

■ 遥控ON-OFF开关

遥控ON-OFF开关	AC输出状态
开路	正常工作
短路	停止工作

■ 交流输出电压、频率、省电模式可通过DIP SW选择

出厂设置为110Vac/60Hz或230Vac/50Hz, 用户可通过拨码开关位置1、2、3、4来调节电压和频率。

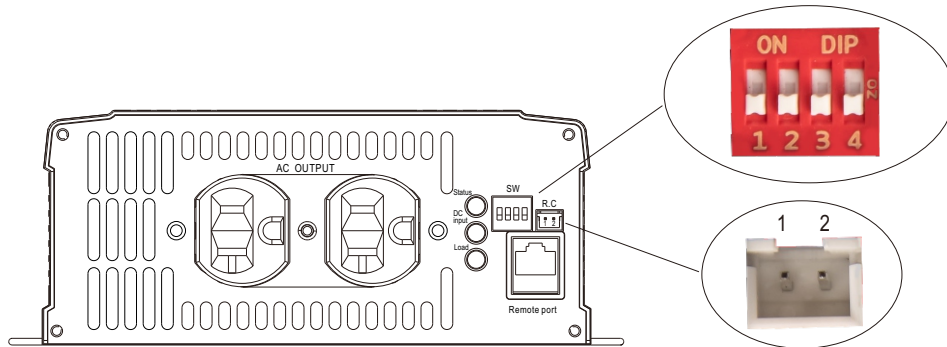















Type-US



交流输出电压、频率、省电模式可通过DIP SW选择			
SW1	SW2	SW3	SW4
OFF	OFF : 100Vac or 200Vac	ON : 50Hz	ON : 省电模式
OFF	ON : 110Vac or 220Vac		
ON	OFF : 115Vac or 230Vac	OFF: 60Hz	OFF: 非省电模式
ON	ON : 120Vac or 240Vac		

■ LED 灯号说明

正常工作：

状态	绿色	橙色	红色
	 系统检测  正常工作	 遥控断电  省电模式	 报警状态 (见下表)

直流输入	绿色	橙色	红色
	 12.5~15.5Vdc  25~31Vdc  50~62Vdc	 11~12.5Vdc  22~25Vdc  44~50Vdc	 <11Vdc or >15.5Vdc  <22Vdc or >31Vdc  <44Vdc or >62Vdc

负载	绿色	橙色	红色
	 <40% 负载	 40~80% 负载	 >80% 负载

报警模式：

LED显示器	报警显示器
状态  DC 输入  负载 	输出过载或交流输出短路
状态  DC 输入  负载 	直流电压异常
状态  DC 输入  负载 	过温或风扇锁住
状态  DC 输入  负载 	逆变器故障

-  恒亮
-  熄灭
-  闪烁

■ 机构尺寸

Unit:mm

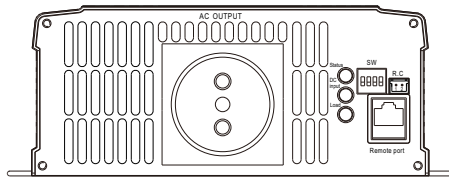
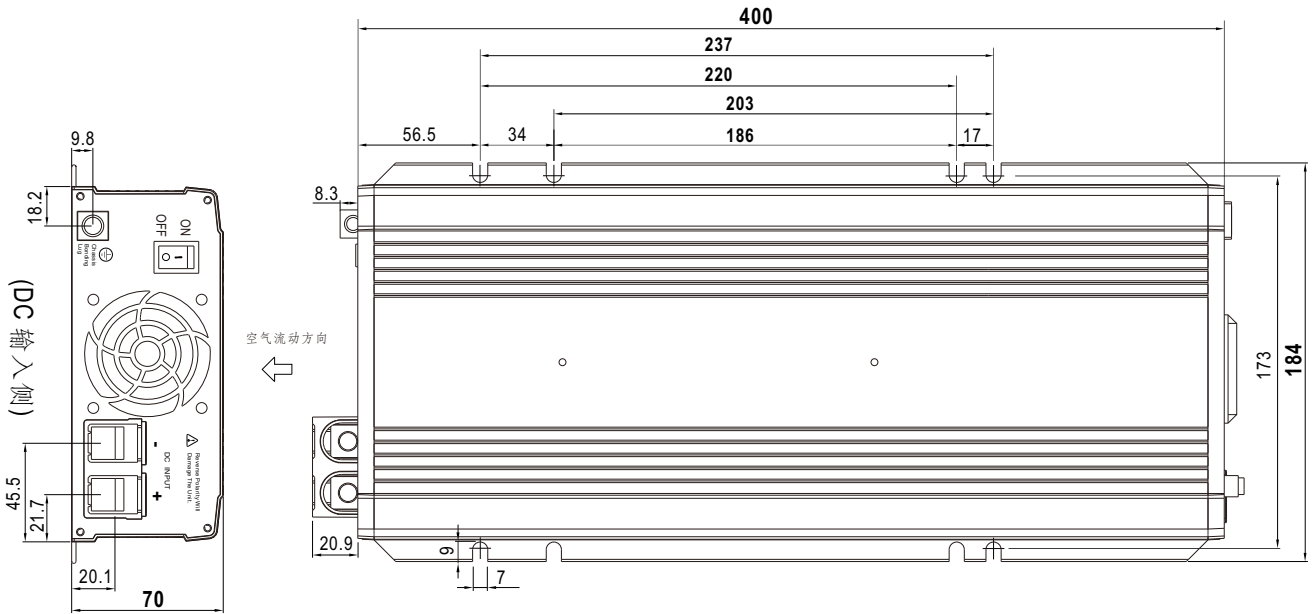

Type-EU

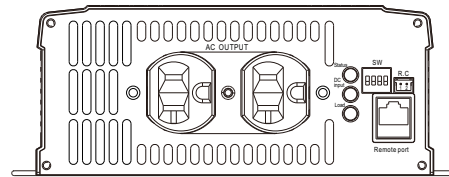

Type-US

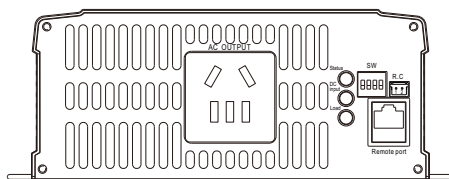

Type-CN

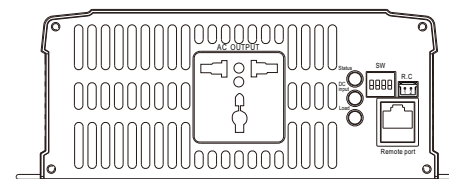

Type-UN

(AC 输出侧)

R.C 连接器: JST B-XH 或同等级品

远程控制	匹配端子	端子型号
Pin 1,2 开路: 正常工作	JST XHP	JST SXH-001T
Pin 1,2 短路: 遥控关闭	或同等级品	或同等级品

Remote port connector (RJ11)



Remote port

功能	Rx	GND	Tx
远程端口	2	3	4
DB9	3	5	2

■ 配件列表

※ 通讯线(选配配件，逆变器和通讯线需单独订购)

明纬订单编号	物件	数量
RJ11-RS232		1

※ 提手(选配配件，逆变器和提手需单独订购)

明纬订单编号	物件	数量
Carry Handle	① 提手 	1
	② 脚垫 	4
	③ 螺丝 	2

① 提手

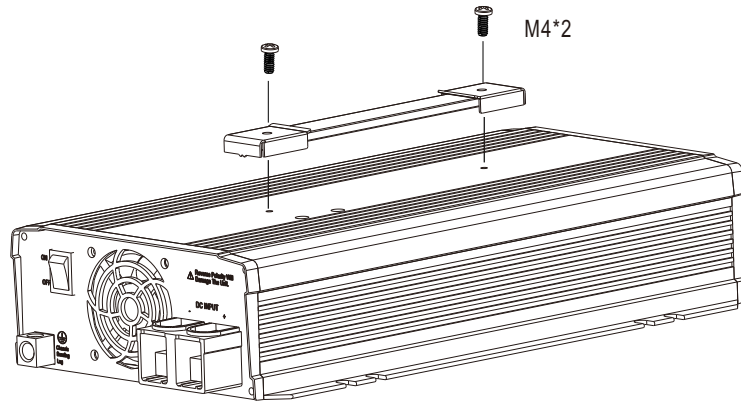

② 脚垫

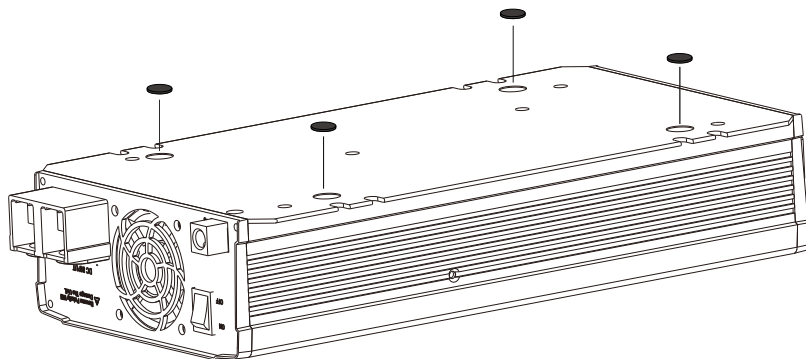

■ 典型应用

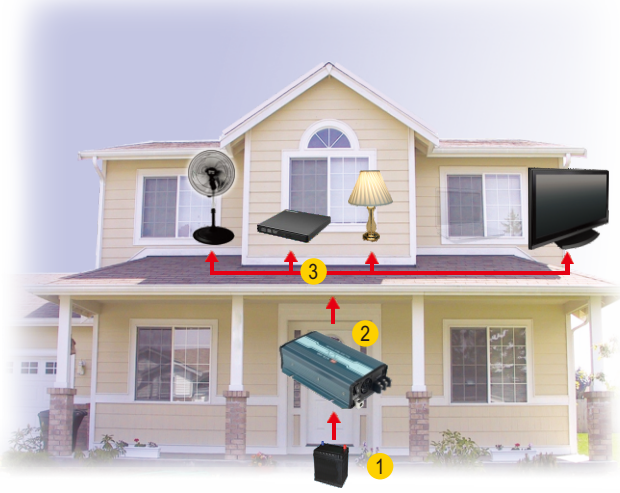

- ① 电池组
- ② 离网DC/AC太阳能逆变器(NTS系列)
- ③ AC插座



- ① 实用程序输入(海岸)
- ② AC/DC电池充电器(PB/NPB/NPP系列)
- ③ 电池组
- ④ 离网DC/AC逆变器(NTS系列)
- ⑤ AC插座

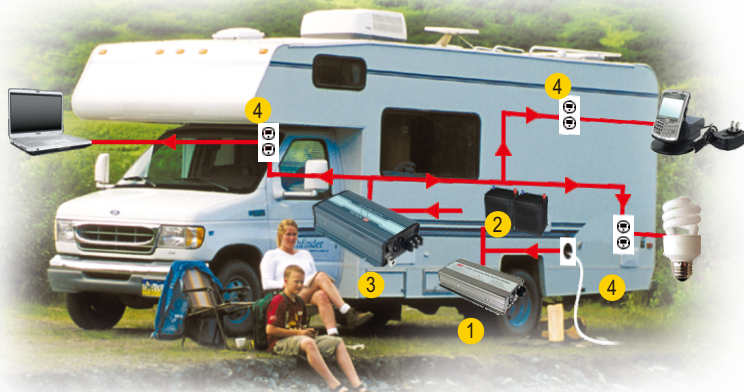

- ① AC/DC电池充电器(PB/NPB/NPP系列)
- ② 电池组
- ③ 离网DC/AC逆变器(NTS系列)
- ④ AC插座