

# 通用铝合金型材

## 线槽型材

代码	材质	表面处理
ATY05-F	A6063-T5	喷砂氧化

- ① 最大使用长度：5800~5850mm；  
整条标准长度：6000~6020mm。
- ② 可定制表面处理。

■ L长度公差

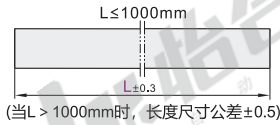

ATY05-F-2040AB  
ATY05-F-3030AB  
ATY05-F-3060AB  
ATY05-F-4040AB  
ATY05-F-4080AB

ATY05-F-3030CD ATY05-F-6030CD  
ATY05-F-3060CD ATY05-F-6060CD  
ATY05-F-4040CD ATY05-F-8040CD  
ATY05-F-4080CD ATY05-F-5050CD

ATY05-F-3060GD  
ATY05-F-4060GD  
ATY05-F-4080GD  
ATY05-F-5050GD  
ATY05-F-50100GD

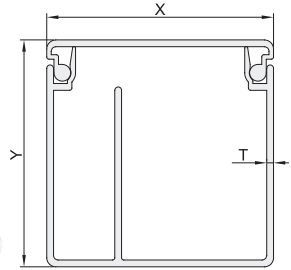
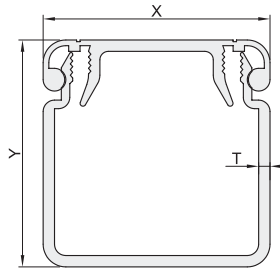
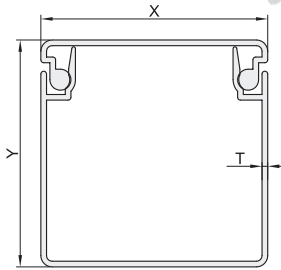

ATY05-F-8080CD  
ATY05-F-50100CD

ATY05-F-100100CD

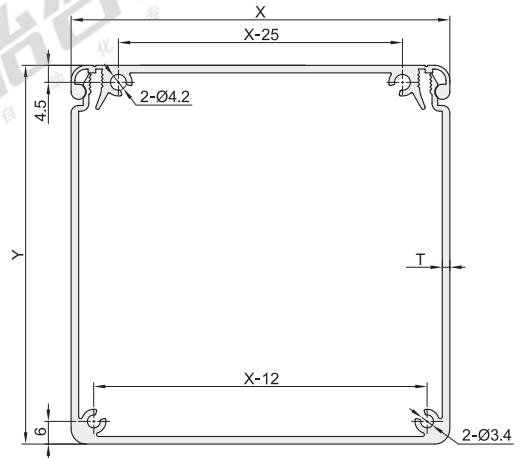
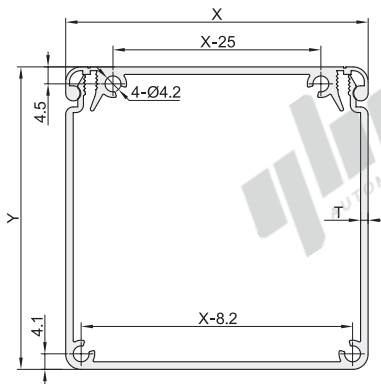

ATY05-F-80160CD

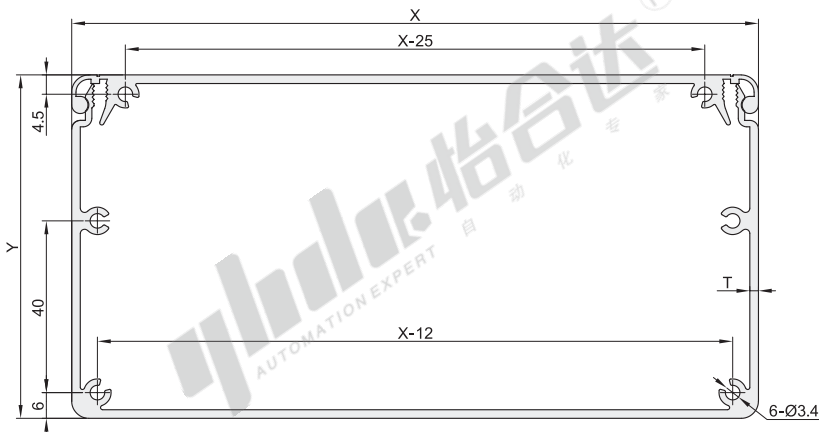

视角标准：第一视角

40系列  
ATY05-F-40A

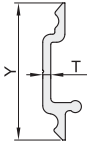

ATY05-F-40C

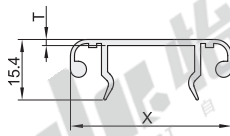

ATY05-F-40D

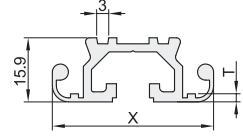

80系列  
ATY05-F-80A

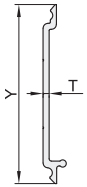

ATY05-F-80C

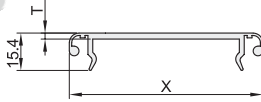

ATY05-F-80D

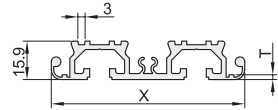

120系列  
ATY05-F-120A

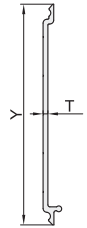

ATY05-F-120C

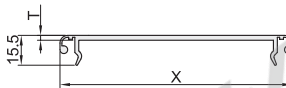

ATY05-F-120D

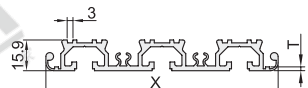

160系列  
ATY05-F-160A

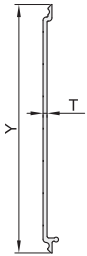

ATY05-F-160C

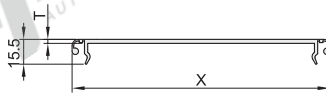

ATY05-F-160D

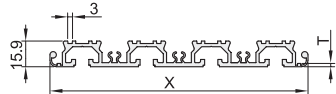

槽口详图

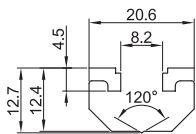

线槽型材组合示意图

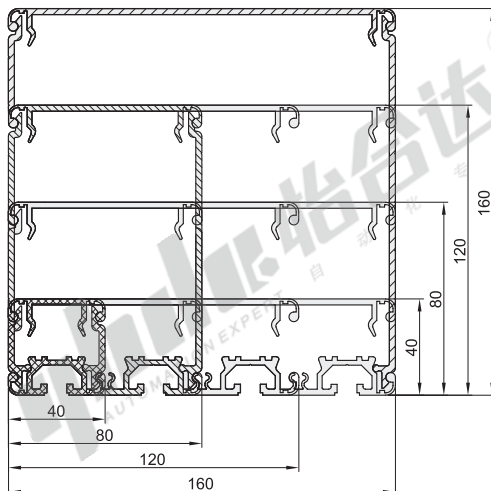

线槽型材组装图

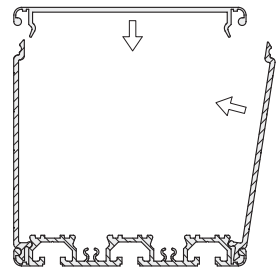

组合线槽示意图

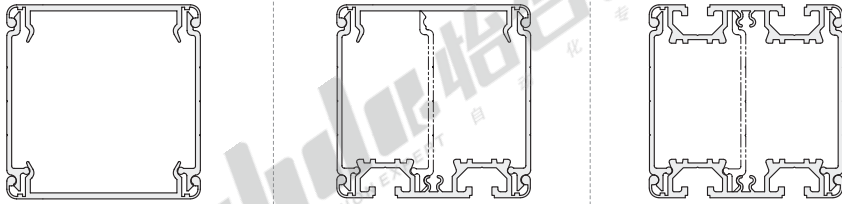

因为支撑型材和壁板型材外部尺寸相同，所以可以选择型材相应位置构建不同线槽，用来满足客户的需求。



代码	型号	规格	L			T	每米重量Kg/m (理论值)	截面积 (mm <sup>2</sup> )
			最小单位0.5	Y	X			
ATY05-F	2040AB			20	40	1	0.45	163.85
	3030AB			30	30		0.45	163.29
	3060AB				60		0.62	223.21
	4040AB			40	40		0.56	203.85
	4080AB				80		0.78	283.21
	3030CD			30	30		0.73	263.66
	3060CD				60		1.06	383.66
	4040CD			40	40		0.95	343.66
	4080CD				80		1.39	504.66
	6030CD				30		1.06	383.65
	6060CD			60	60	1.39	503.66	
	8040CD				40	1.39	503.65	
	8080CD			80	80	1.96	711.24	
	5050CD			50	50	1.17	423.66	
	50100CD				100	1.85	671.24	
	100100CD			100	100	2.50	907.08	
	80160CD		50~6000	80	160	3.07	1116.36	
	3060GD			30	60	0.91	331.44	
	4060GD			40	60	1.04	376.44	
	4080GD				80	1.21	439.38	
	5050GD			50	50	1.09	395.23	
	50100GD				100	1.50	545.22	
	40A			34	—	0.21	75.27	
	40C			—	40	0.35	127.25	
	40D			—	—	0.58	211.20	
	80A			74	—	0.47	171.41	
	80C			—	80	0.64	231.86	
	80D			—	—	1.18	426.27	
	120A			114	—	0.83	300.23	
	120C			—	—	1.00	362.16	
120D			—	120	1.77	641.35		
160A			154	—	1.10	400.08		
160C			—	—	1.27	462.16		
160D			—	160	2.36	856.42		



型号		L
代码	规格	最小单位0.5
ATY05-F	3030AB	50~6000
	4040CD	

请按图示订货 ATY05-F—3030AB—L800