

欧标40槽宽10.2系列铝合金型材

◀ 边长40/80mm

代码	材质	表面处理
AOB02	A6063-T6	碱砂氧化
AOH02	A6005-T6	
AOB03	A6063-T5	黑色氧化
AOB05		喷砂氧化

- ① 切断面未进行氧化处理。
- ② 最大使用长度：5800~5850mm；
整条标准长度：6000~6020mm。
- ③ 可定制表面处理。

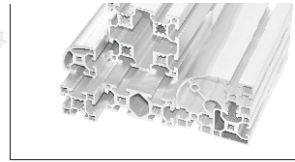

● L长度公差

L ≤ 1000mm

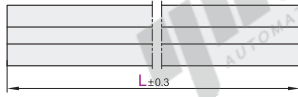

(当L > 1000mm时, 长度尺寸公差±0.5)

● 槽口详图

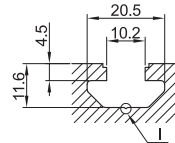
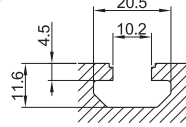

I局部放大图

AOB02-H4040
AOB03-H4040
AOB05-H4040

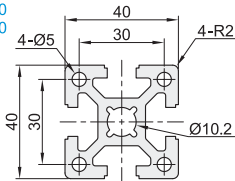

AOH02-4040

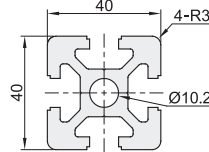

AOB02-H4040C

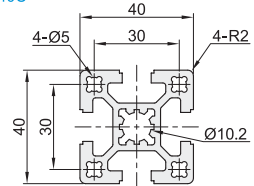

AOB02-H4040E

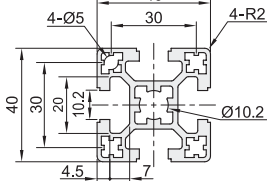

AOB02-H4040A
AOB03-H4040A

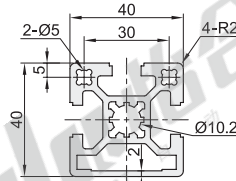

AOB02-H4040B
AOB03-H4040B

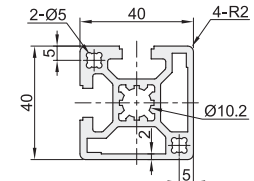

AOB02-H4040H

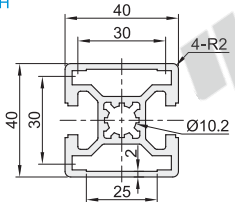

AOB02-H4040T

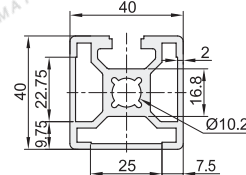

AOB02-H4040R

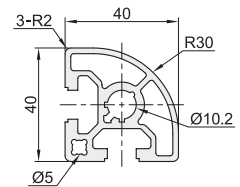

AOB02-H4040RS

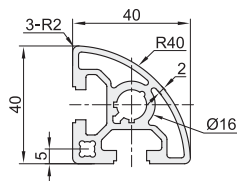

AOB02-H4060

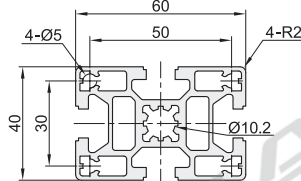

AOB02-H4080
AOB03-H4080
AOB05-H4080

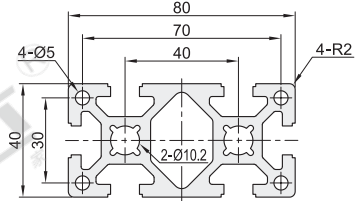

AOH02-4080

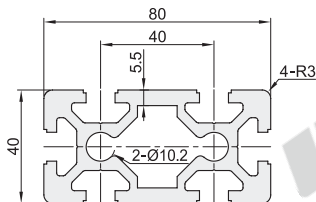

AOB02-H4080C

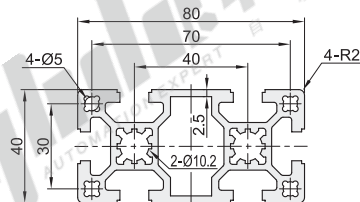

AOB02-H4080H

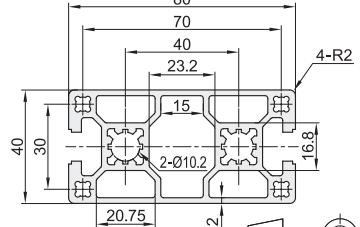

视角标准：第一视角

槽宽10.2系列
欧标40

AOB02-H8080
AOB03-H8080

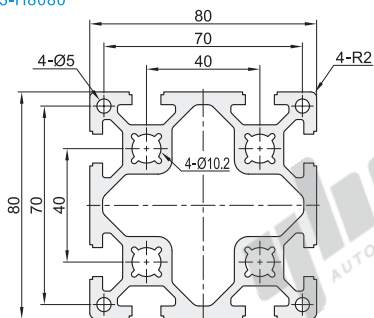

AOB02-H8080C

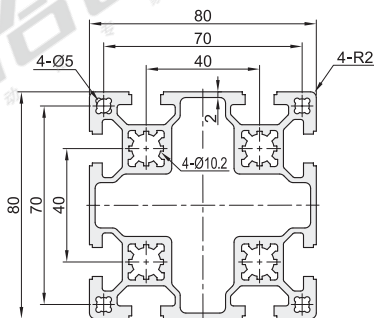

AOB02-H8840

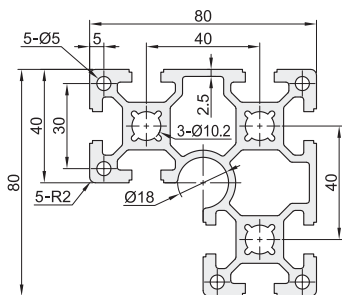

AOB02-H8840R

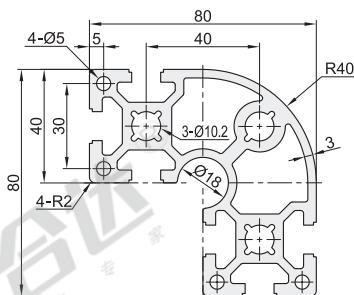

AOB02-H40120C

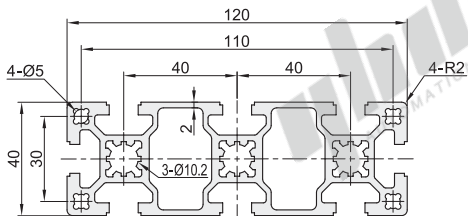

AOB02-H40160C

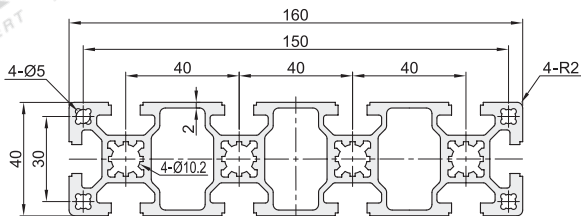

AOB02-H80120

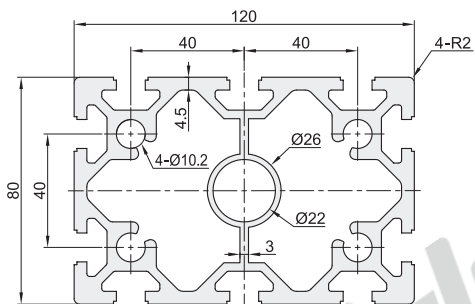

AOB02-H120120

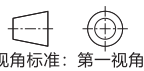
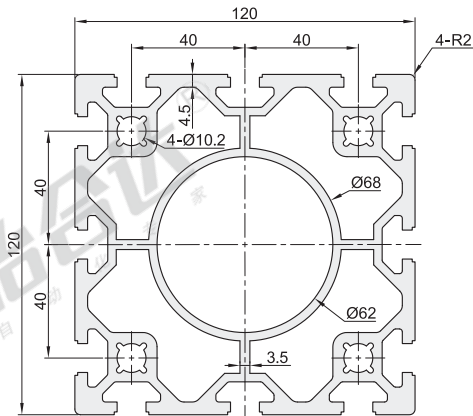

视角标准：第一视角

欧标40槽宽10.2系列铝合金型材

边长160mm

AOB02-H80160

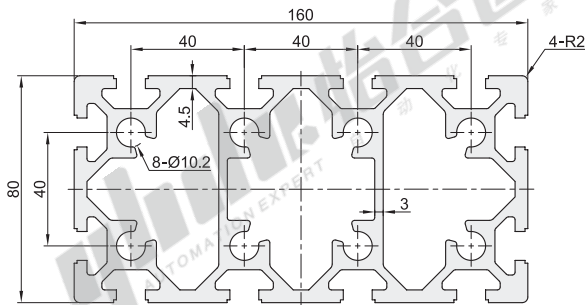

代码	型号 规格	L 最小单位0.5	截面尺寸	每米重量Kg/m (理论值)	截面积 (mm²)	截面惯性矩		抗弯截面模数	
						I_x	I_y	W_{xmax} (mm³)	W_{ymax} (mm³)
AOB02	H4040	50~6000	40×40	2.00	724.84	11.58×10^4	11.58×10^4	5792.15	5792.15
	H4040A			1.71	621.97	10.23×10^4	10.30×10^4	4977.26	5148.80
	H4040B			1.70	618.19	10.25×10^4	10.25×10^4	5098.23	5098.23
	H4040C			1.78	647.87	10.69×10^4	10.69×10^4	5346.25	5346.25
	H4040E			1.56	566.13	9.07×10^4	9.07×10^4	4534.00	4534.00
	H4040H			1.64	596.08	9.813×10^4	9.903×10^4	4906.50	4951.50
	H4040T			1.71	619.52	9.784×10^4	10.003×10^4	4849.75	5001.38
	H4040R			1.46	528.63	7.59×10^4	7.58×10^4	3410.66	3410.66
	H4040RS			1.41	511.61	5.325×10^4	8.313×10^4	2325.08	3629.75
	H4060			2.34	848.00	13.47×10^4	27.93×10^4	6734.45	9311.60
	H4080			3.64	1324.10	22.41×10^4	81.28×10^4	11206.10	20318.65
	H4080C			3.04	1104.02	19.21×10^4	73.06×10^4	9603.10	18266.03
	H4080H			2.87	1043.15	18.673×10^4	70.919×10^4	9336.42	17729.87
	H8840			4.67	1699.32	101.00×10^4	101.00×10^4	21964.98	21964.98
	H8840R			4.61	1676.82	94.11×10^4	94.21×10^4	21233.83	21247.60
	H8080			5.92	2153.30	151.28×10^4	151.28×10^4	37820.48	37820.48
H8080C	4.70	1706.89	122.50×10^4	122.50×10^4	30623.68	30623.68			
H40120C	4.15	1509.82	25.99×10^4	221.75×10^4	12998.85	36957.48			
H40160C	5.34	1940.79	33.65×10^4	491.21×10^4	16825.15	61401.30			
H80120	7.91	2876.99	223.86×10^4	468.05×10^4	55963.90	78008.35			
H80160	10.46	3802.91	299.15×10^4	1016.18×10^4	74787.25	127022.98			
H120120	11.05	4016.02	668.58×10^4	668.56×10^4	111429.95	111426.12			
AOH02	4040		40×40	2.24	813.02	13.23×10^4	13.23×10^4	6615.00	6615.00
	4080		40×80	3.75	1362.86	24.30×10^4	90.15×10^4	12150.35	22536.60
AOB03	H4040		40×40	2.00	724.84	11.58×10^4	11.58×10^4	5792.15	5792.15
	H4040A		40×40	1.71	621.97	10.23×10^4	10.30×10^4	4977.26	5148.80
	H4040B		40×40	1.70	618.19	10.25×10^4	10.25×10^4	5098.23	5098.23
	H4080		40×80	3.64	1324.10	22.41×10^4	81.28×10^4	11206.10	20318.65
AOB05	H8080		80×80	5.92	2153.30	151.28×10^4	151.28×10^4	37820.48	37820.48
	H4040		40×40	2.00	724.84	11.58×10^4	11.58×10^4	5792.15	5792.15
	H4080		40×80	3.64	1324.10	22.41×10^4	81.28×10^4	11206.10	20318.65

槽宽102系列
欧标40



请按图示订货

型号	规格	L 最小单位0.5	截面尺寸
AOB02	H4040 H4040A	50~6000	40×40

AOB02—H4040A—L550

可选加工

型号	规格	L 最小单位0.5	可选加工代码
AOB02	H4040 H4040A	50~6000	LM RM DM

AOB02—H4040A—L550—RM



可选加工

端面螺孔加工

代码	技术说明	
	变更通孔为螺孔	
	选型方法	LM/RM/DM
		<p>① Ø10.2通孔变更为螺孔M12深28。</p> <p>② AOB02-H4040R/AOB02-H8840R仅适用端面螺孔加工。</p> <p>③ 可选加工见P603-608。</p>

LM(左端面)

RM(右端面)

DM(双端面)

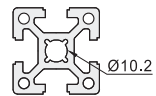

① Ø10.2通孔变更为螺孔M12深28。

② AOB02-H4040R/AOB02-H8840R仅适用端面螺孔加工。

③ 可选加工见P603-608。

