

型材连接板

代码	类型	材质	表面处理
ACC31-G306	型材连接板	SUS304	单面拉丝

- ① 用于型材一形、十字形、L形、T形结构的高强度连接。
- ② 根据设计需求，孔距、长度可来图加工。

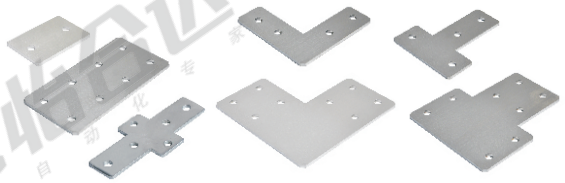

ACC31-G306-Y-3030

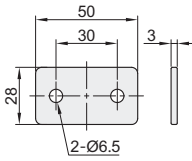

ACC31-G306-Y-3060C

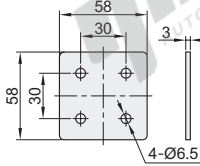

ACC31-G306-Y-3060

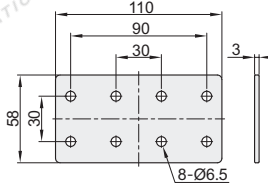

ACC31-G306-X-3030

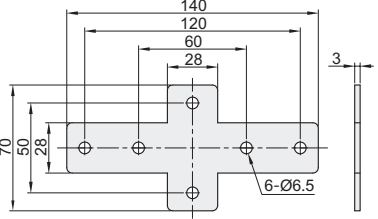

ACC31-G306-X-3060

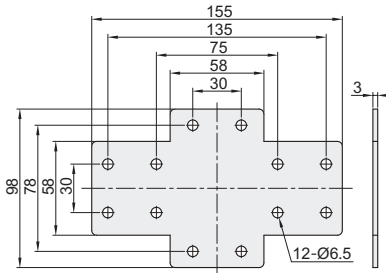

ACC31-G306-L-3030

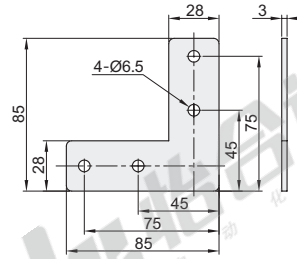

ACC31-G306-L-3060

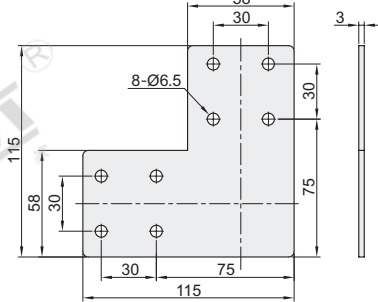

ACC31-G306-T-3030

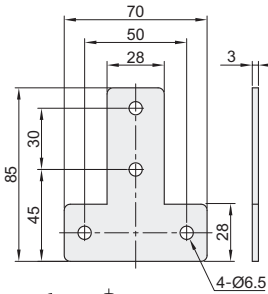

ACC31-G306-T-3060

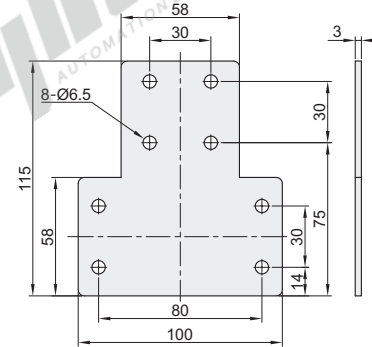

ACC31-G306-A-3030

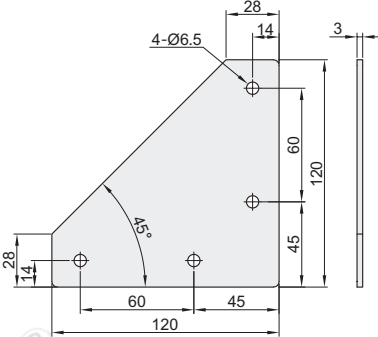

视角标准：第一视角

代码	重量(g/pcs)	代码	重量(g/pcs)
ACC31-G306-Y-3030	31	ACC31-G306-L-3030	88
ACC31-G306-Y-3060	128	ACC31-G306-L-3060	226
ACC31-G306-Y-3060C	75	ACC31-G306-T-3030	73
ACC31-G306-X-3030	102	ACC31-G306-T-3060	206
ACC31-G306-X-3060	159	ACC31-G306-A-3030	241

型号 ACC31-G306-X-3030-SET-OB



可增加加工

增加加工项目	代码	技术说明
配备合适的螺栓, T型螺母和垫片	SET-OB	指定SET时, 配备将型材连接板固定在型材上的螺栓, 螺母, 垫片。 (例)螺栓: AID31-M6-L12 T型螺母: AHC21-308-M6 垫片: AIK31-6 弹垫: AIH21-6



十字形连接板使用示例

Example 使用示例

AIH21-6 (P540)

分解图

AID31-M6-L12 (P539)

AIK31-6 (P540)

AHC21-308-M6 (P229)

AOB05-3030 (P195)

组装图

扳手

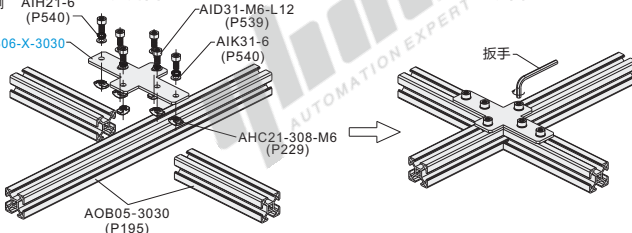

请按图订货

型号

- ACC31-G306-Y-3030
- ACC31-G306-Y-3060
- ACC31-G306-X-3030