

机械防护栏30/40系列配件

铁丝固定块

代码	AVK31-4010
类型	铁丝固定块
材质	不锈钢
表面处理	—
重量(g/pcs)	94

① 用于铁丝网在型材槽中的固定。

AVK31-4010

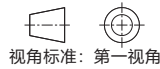
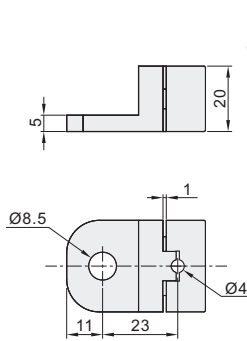

EX Example 使用示例

分解图

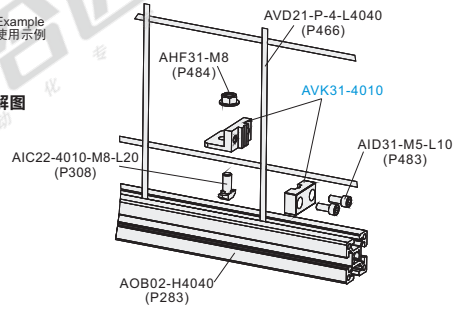

组装图

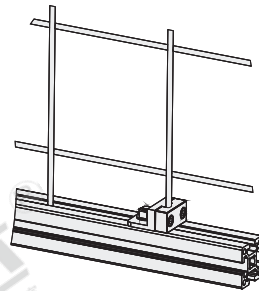

铁丝固定块

代码	AVK31-3030W
类型	铁丝固定块
材质	不锈钢
表面处理	—
重量(g/pcs)	88

① 用于铁丝网在型材槽中的固定。

AVK31-3030W

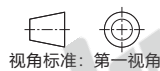
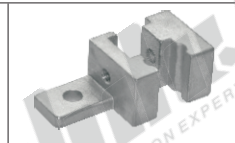
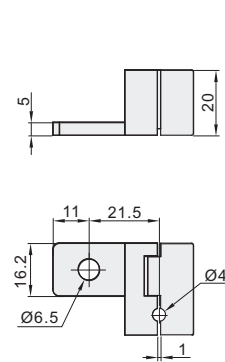

EX Example 使用示例

分解图

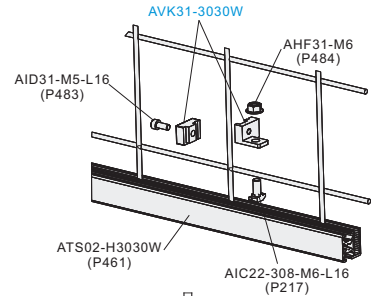

组装图

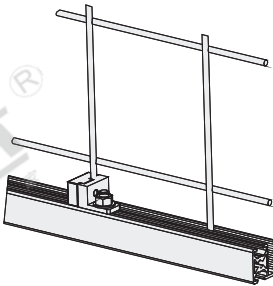

型号
AVK31-4010
AVK31-3030W



怡合达
AUTOMATION EXPERT